



New Flagship



NEW

Electrical Safety Multi-analyzer TOS9300 Series

All-in-one safety tester model (TOS9303LC)

Insulation diagnosis available with partial discharge model (TOS9301PD <Under development>)

New amplifier type allows for 40 A AC/DC ground bond testing (Ground bond tester models)

Electrical breakdown inspection setting available

AC5 kV/100 mA, DC7.2 kV/100 W Hipot test

Touch current/protective conductor current/leakage current test (TOS9303LC)

LAN/USB/RS232C standard digital interface

Easy to read LCD display for real time monitoring during tests

All measurement values and standard outlines displayed in each test

High voltage scanner capable of output distribution both standalone and when connected with existing withstanding voltage/insulation resistance testing equipment models [TOS5300 series, etc.] (TOS9320)



THE ALL-ROUN

Hipot, Insulation Resistance, Ground Bond, Leakage or Partial Discharge, this analyzer covers it all!

TOS9300 Series Lineup

TOS9300

AC Hipot Tester with Insulation Resistance Test



ACW 5 kV/100 mA(500 VA)
 IR 0.001 M Ω to 100.0 G Ω (DC-25 V to -1000 V)
  LAN USB RS232C 



D 430(16.93")(440(17.32"))W×132(5.2")(155(6.10"))H×
 370(14.57")(410(16.14"))Dmm (inch)
 W Approx.17 kg(37.5 lbs)

TOS9301

AC/DC Hipot Tester with Insulation Resistance Test

ACW 5 kV/100 mA(500 VA)
 DCW 5 kV/20 mA, 7.2 kV/13.9 mA(100 W)
 IR 0.001 M Ω to 100.0 G Ω (DC-25 V to -1000 V/DC+50 V to +7200 V)
  LAN USB RS232C 



D 430(16.93")(440(17.32"))W×132(5.2")(155(6.10"))H×
 370(14.57")(410(16.14"))Dmm (inch)
 W Approx.18 kg(39.7 lbs)

TOS9301PD

Under development

AC/DC Hipot Tester with Insulation Resistance and Partial Discharge Test

ACW 5 kV/100 mA(500 VA)
 DCW 5 kV/20 mA, 7.2 kV/13.9 mA(100 W)
 IR 0.001 M Ω to 100.0 G Ω (DC-25 V to -1000 V/DC+50 V to +7200 V)
 PD
  LAN USB RS232C 



D 430(16.93")(440(17.32"))W×132(5.2")(155(6.10"))H×
 500(19.69")(540(21.26"))Dmm (inch)
 W Approx.24 kg(52.9 lbs)

TOS9302

AC Hipot Tester with Ground Bond Test



ACW 5 kV/100 mA(500 VA)
 EC 0.001 Ω to 0.600 Ω (3.0 A to 42.0 A)
  LAN USB RS232C 



D 430(16.93")(440(17.32"))W×132(5.2")(155(6.10"))H×
 500(19.69")(540(21.26"))Dmm (inch)
 W Approx.20 kg(44.1 lbs)

TOS9303

AC/DC Hipot Tester with Insulation Resistance and Ground Bond Test



ACW 5 kV/100 mA(500 VA)
 DCW 5 kV/20 mA, 7.2 kV/13.9 mA(100 W)
 IR 0.001 M Ω to 100.0 G Ω (DC-25 V to -1000 V/DC+50 V to +7200 V)
 EC 0.001 Ω to 0.600 Ω (3.0 A to 42.0 A)
  LAN USB RS232C 



D 430(16.93")(440(17.32"))W×132(5.2")(155(6.10"))H×
 500(19.69")(540(21.26"))Dmm (inch)
 W Approx.21 kg(46.3 lbs)

TOS9303LC







AC/DC Hipot Tester with Insulation Resistance, Ground Bond, and Leakage Current Test

ACW 5 kV/100 mA(500 VA)
 DCW 5 kV/20 mA, 7.2 kV/13.9 mA(100 W)
 IR 0.001 M Ω to 100.0 G Ω (DC-25 V to -1000 V/DC+50 V to +7200 V)
 EC 0.001 Ω to 0.600 Ω (3.0 A to 42.0 A)
 LC 1 μ A to 100 mA(rms)
  LAN USB RS232C 



D 430(16.93")(440(17.32"))W×132(5.2")(155(6.10"))H×
 500(19.69")(550(21.65"))Dmm (inch)
 W Approx.22 kg(48.5 lbs)

● Test items

Model	 AC Withstanding Voltage (AC Hipot)	 DC Withstanding Voltage (DC Hipot)	 Insulation Resistance	 Earth Continuity (Ground Bond)	 Leakage Current	 Partial Discharge
TOS9300	●		●			
TOS9301	●	●	●			
TOS9301PD <small>Under development</small>	●	●	●			●
TOS9302	●			●		
TOS9303	●	●	●	●		
TOS9303LC	●	●	●	●	●	
TOS9320	4 channel high voltage scanner with contact check function; can be used standalone.					

DER



TOS SAFETY ANALYZER
9300
SERIES



Electrical Safety Multi-analyzer TOS9300 Series

NEW

The TOS9300 series is a high performance electrical safety analyzer that complies to a wide range of universal standards. Hipot, Insulation Resistance, Ground Bond, Leakage Current (touch current and protective conductor current) and partial discharge can all be tested. A total of 6 models are available for standard compliance tests in a wide variety of applications including R&D, quality assurance manufacturing lines and laboratory tests.

- All-in-one safety tester model (TOS9303LC)
- Insulation diagnosis available with partial discharge model (TOS9301PD [Under development])
- New amplifier type allows for 40A AC/DC ground bond testing (Ground bond tester models)
- Electrical breakdown inspection setting available
- AC5 kV/100 mA, DC7.2 kV/100 W Hipot test
- Touch current/protective conductor current/leakage current testing (TOS9303LC)
- LAN/USB/RS232C standard digital interface
- Easy to read LCD display for real time monitoring during tests,
All measurement values and standard outlines displayed in each test
- High voltage scanner capable of output distribution both standalone and when connected with existing withstanding voltage/insulation resistance testing equipment models [TOS5300 series, etc.] (TOS9320)

Option

TOS9320

High-voltage Scanner

High voltage scanner for TOS9300 series multi-channel testing systems



D 430(16.93")(440(17.32"))W×88(3.46")(105(4.13"))H×
370(14.57")(390(15.35"))Dmm(inch)
W Approx. 8 kg (17.6 lbs)

Others



- Remote Control Box
- High voltage test probe
- Test probe for touch current test
- Warning Light Unit
- Multi Outlet
- DIN conversion cable
- Rack Mount Bracket

Features P4-P7

Applications p8-9

Exterior Design p10-11

Specifications P12-P24

Dimensions p25

Option/Other P26-P27

ACW Max. output-voltage of AC hipot testing	Equipped with rise time control function	D Dimensions(maximum)
DCW Max. output-voltage of DC hipot testing	Equipped with fall time control function	W Weight
IR Measurement range of insulation resistance testing	Equipped with LAN interface as standard	Equipped with timer function
EC Measurement range of ground bond testing	Equipped with USB interface as standard	
LC Measurement range of leakage current testing	Equipped with RS232C interface as standard	
PD Measurement range of partial discharge testing		

The Electrical Appliance & Material Safety Low (Japan), UL (U.S.A.), CSA (Canada), VDE (Germany) and BS (U.K.) are some major examples of safety standards in use throughout the world that require the performing of hipot testing. For this reason, it is necessary to confirm for what portion of what standard testing is to be performed when purchasing a hipot tester. Although the 500 VA capacity hipot testers available from KIKUSUI can basically be applied to tests specified in all safety stand-ards, we recommend that you consult with us prior to purchase in order to select the model that best matches your specific application.

For the withstanding test and the insulation resistance test of the EUT (Equipment Under Test) with turned on electricity.

Our Hipot Testers and Insulation Resistance Testers are designed to test the EUT (Equipment Under Test) with turned off electricity. In case the test requires the EUT (Equipment Under Test) with turned on electricity, please contact with our distributor or agent.

Features

Color LCD Screen for Improved Visibility!

A brand-new 7-inch LCD display allows for easy access to your custom settings, standard outlines and blueprints for easy operation. (See Exterior Design P10/Display P11)

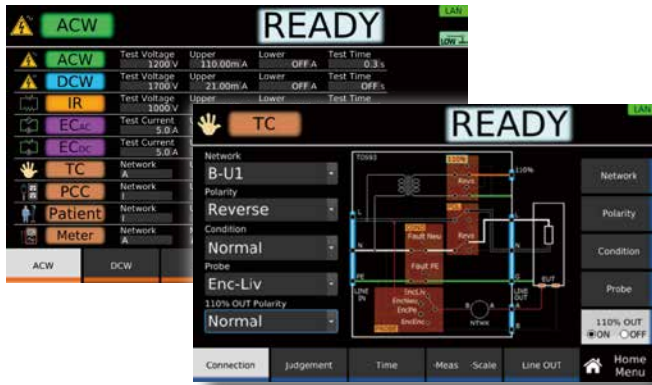

User-Friendly 10Key Configuration

The TOS9300 series has included a user-friendly keypad in addition to the basic rotary knob for easy setting configuration. The front panel USB interface also allows for direct control via keyboard*.



*106/109 Japanese keyboards and 101/104 English keyboard compliant.

Easy Firmware Updates via USB

System firmware can easily be updated via USB memory with update files directly accessible from our website. (<https://www.kikusui.co.jp/en/download/>)



LAN/USB/RS232C Standard Digital Interface

LXI compatible LAN, USB 2.0, USB-TMC compatible USB, and RS232C as standard digital interface.



▲ Rear panel Interface (All models)

◀ Use a browser from a PC, smartphone, or tablet to access the web server built into the TOS9300 series for convenient control and monitoring.

[Recommended browser]

- Requires for the Internet Explorer version 9.0 or later
- Requires for the firefox 8.0 or later
- Requires for the safari / mobile Safari 5.1 or later
- Requires for the Chrome 15.0 or later
- Requires for the Opera 11.0 or later

* Connecting with a smartphone, tablet, etc. requires a Wi-Fi environment (wireless LAN router etc.).

I/V Monitor Terminal (Analog Monitor)

Signal outputs on the rear panel I/V terminal allow the user to monitor current/voltage waveforms during hipot tests with only an oscilloscope. Current sensors and high voltage probes not required.

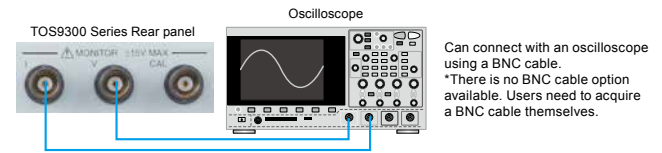

Can connect with an oscilloscope using a BNC cable.
*There is no BNC cable option available. Users need to acquire a BNC cable themselves.

STATUS OUT Connector

Signals from the rear panel STATUS connector automatically activate the optional warning light (PL02-TOS) during high voltage output or unsafe test conditions.



SIGNAL I/O Connector

The rear panel also has a SIGNAL I/O that can start/stop operation as well as output signals.

TOS9300 example (The SIGNAL I/O connector is the same on all models.)

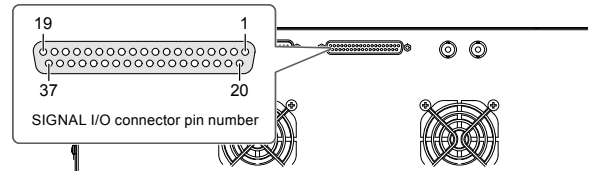

Pin no.	IN/OUT	Signal name	Description
1	IN	INTERLOCK+	Activate/release interlock.
2	—	COM	Circuit common (chassis potential) shared by input and output.
3	IN	PM0	Select setup memories and auto test program memories.
4	IN	PM1	
5	IN	PM2	
6	IN	PM3	
7	IN	PM4	
8	IN	PM5	
9	IN	PM6	
10	IN	PM7	
11	IN	STB	Recall setup memories and programs selected with the PM0 to PM7 signals.
12	—	Reserved	Not used.
13	—	Reserved	
14	—	Reserved	
15	IN	START	Start a test.
16	IN	STOP	Stop a test.
17	IN	ENABLE	Enable the START signal.
18	—	COM	I/O circuit common (chassis potential).
19	IN	INTERLOCK-	Activate/release interlock.
20	—	COM	I/O circuit common (chassis potential).
21	—	+24V	+24 V internal power supply output terminal. Maximum output current 100 mA.
22	OUT	H.V ON/LINE ON	Set to on in any of the following conditions. Testing, Auto testing. Voltage remaining across the output terminals. Power being supplied to the EUT from the TOS9303LC through AC LINE OUT.
23	OUT	RISE	Set to on when the voltage is rising.
24	OUT	TEST	Set to on during test time.
25	OUT	PASS	Set to on for the duration of time specified by Pass Hold when a PASS judgment is made.
26	OUT	U FAIL	Set to on continuously when a U-FAIL judgment is made. Or set to on continuously along with the L FAIL signal when CONTACT FAIL judgment is made when a scanner is connected.
27	OUT	L FAIL	Set to on continuously when an L-FAIL judgment is made. Or set to on continuously along with the U FAIL signal when CONTACT FAIL judgment is made when a scanner is connected.
28	—	Reserved	Not used.
29	OUT	READY	Set to on when the product is ready to start a test.
30	OUT	PROTECTION	Set to on when a protection function is activated.
31	OUT	STEP END	Set to on when each step ends during an auto test.
32	OUT	CYCLE END	Set to on when the last step ends during an auto test.
33	OUT	ACW	Set to on when the test mode is set to AC withstanding voltage test.
34	OUT	DCW	Set to on when the test mode is set to DC withstanding voltage test.
35	OUT	IR	Set to on when the test mode is set to insulation resistance test.
36	OUT	EC	Set to on when the test mode is set to earth continuity test.
37	OUT	LC	Set to on when the test mode is set to touch current test or protective conductor test.

Universal Input Support

● Global Support

TOS9300 Series supports universal input for varying input voltages around the world.

● Programmable Output Frequency
Stable output frequency not dependent on input power source. Testing voltage is supplied at a stable 50/60Hz frequency.



AC Hipot Testing with Stable Output [Input Voltage Variation: ±0.3%]

Conventional hipot testers utilize a slide transformer to output AC line voltage. This design is susceptible to input voltage fluctuation, with outside electrical influence affecting the test results. This can result in distorted voltage being applied to the EUT which can cause product malfunctions down the line due to component malfunction. The TOS9300 series utilizes a highly efficient PWM amplifier capable of stable high-voltage output that is unaffected by changes in the AC power line. The TOS9300 series allows for safe, stable, and highly reliable tests regardless of AC power line instability.

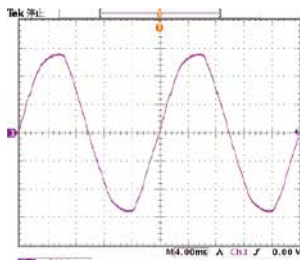
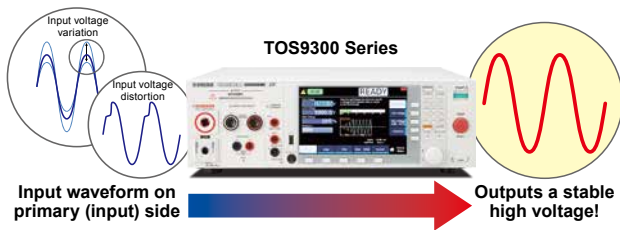

Slide transformer system

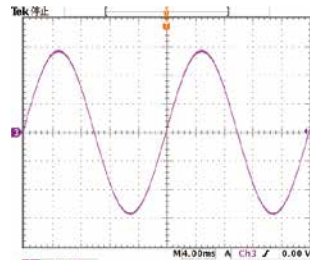

PWM amplifier system

High Precision/High Resolution/High Speed

The TOS9300 is equipped with a highly accurate, high resolution RMS measurement circuit with a voltmeter of $\pm (1.2\% \text{ of reading} + 5 \text{ V})$ /minimum resolution 0.1 V and an ammeter of $\pm (1\% \text{ of reading} + 2 \mu\text{A})$ / minimum resolution 1 μA . The series also supports an auto range function, ensuring similar accuracy in both the upper and lower limit measurements that can accurately detect connection problems in the test lead. This combined with a measurement speed of 0.1s allows for reliable testing with high accuracy and resolution.

Automatic Testing Feature

Tests can be combined and configured to execute automatically over long periods of time. Automatic tests are composed of programs and steps, which can be configured to initiate one after another.

● Program schematic

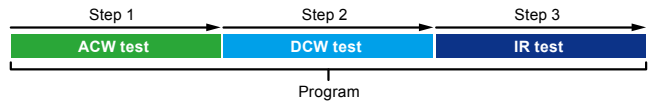

	Maximum number of programs	Maximum number of steps *1	Executed under external control	Changing the program name
Program memory (except LC tests)	100	100	-	✓
Program memory (LC tests only) *2	100	100	-	✓
	Maximum number of programs	Maximum number of steps *1	Executed under external control	Changing the program name
External control program memory (except LC tests)	25	100	✓	-
External control Program memory (LC tests only) *2	25	100	✓	-

*1 Per program *2 TOS9303LC only

Contact/Protective Conductor/ Patient Leakage Current Test (TOS9303LC)

The TOS9300 series can conduct leakage current (patient current) tests for highly sensitive medical devices. Measurement networks can be easily configured via the front panel. (See Applications P8, Specifications P19)

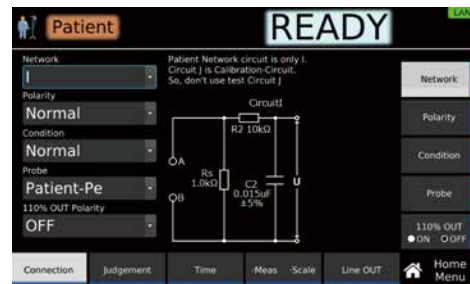

All Electrical Safety Standard Tests in One Device! (TOS9303LC)

The TOS9303LC is the "all-rounder" model which supports AC/DC withstanding voltage, insulation resistance, AC/DC earth continuity and leakage currents tests in a single device. It can also be used for contact current, protective conductor current and patient leakage current tests.

- ACW** 5 kV/100 mA(500 VA)
- DCW** 5 kV/20 mA, 7.2 kV/13.9 mA(100 W)
- IR** 0.001 M Ω to 100.0 G Ω (DC-25 V to -1000 V/DC+50 V to +7200 V)
- EC** 0.001 Ω to 0.600 Ω (3.0 A to 42.0 A)
- LC** 1 μA to 100 mA(rms)

All in One!



▲TOS9303LC

Features

Programmable Detection Response Speed

Conventional withstanding voltage testers are generally used to only detect insulation breakdown, and cannot make judgements on instantaneous discharge currents like partial discharge. However, the TOS9300 series is equipped with 5 levels of response speed settings to accurately detect low levels of insulation breakdown. Small discharges not visible to conventional withstanding voltage testers are easily detected with the TOS9300 series.

Value	Description	
LPF	Slow	Mean-value response type current detector. This is similar to the current detection response of Kikusui's general-purpose AC withstanding voltage testers. This setting is suitable for detecting dielectric breakdown defined in safety standards and for general hipot tests for general electronic devices and components. This setting is not recommended for detecting corona discharge, which is not considered dielectric breakdown by typical safety standards.
	Medium	Mean-value response type faster than SLOW setting. Upper limit judgement detection is much faster, suitable for withstanding voltage tests on compact electronic components and other EUTs prone to dielectric breakdown. Instantaneous discharges such as corona discharges with high frequencies are detected which may not be suitable for simple withstanding voltage tests.
	Fast	Extremely small discharges such as corona discharges are detected but with low reproductibility.
HPF	Slow	Extremely small discharges such as corona discharges are detected but with low reproductibility.
	Fast	Extremely small discharges such as corona discharges are detected but with low reproductibility.

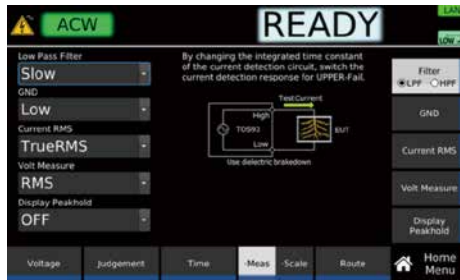

7.2 kV/100 W DC Hipot Test

Capable of performing DC Hipot tests up to 7.2 kV utilizing a stable DC/DC converter with low-ripple and load variation of 1% and below.



Positive Electrode/Negative Electrode Insulation Resistance Testing

Testing voltage from -25 V to -1000 V, +50 V to +7200 V, with a setting resolution is 1 V. Insulation resistance can be tested up to 99.99 GΩ. This makes for easy IEC61730-2 standard PV (solar battery) module insulation resistance testing. (See Application P9)



Electric Discharge Function

A discharge feature enables discharge of electrical energy from the DUT after DC hipot and insulation resistance tests have completed. The setting range for discharge time is between 0.0s - 100.0s.

AC/DC Earth Continuity Testing up to 40 A

Cutting edge amp technology allows for a wide range of applications, including general AC earth conduction testing and EV/PHV system DC earth continuity testing. This also allows for strict adherence to automotive DC standard requirements; expected to increase in the near future.



EARTH FAULT Protection

Mistakenly changing the grounding (GND) setting to "guard" (floating) can result in grounding the test subject which can result in unwanted leakage current emissions from the high voltage output site into the grounding site, resulting in electric shock to the operator. The EARTH FAULT protection function blocks output and terminates the test; eliminating any risk of electric shock and maximizing safety for the operator.

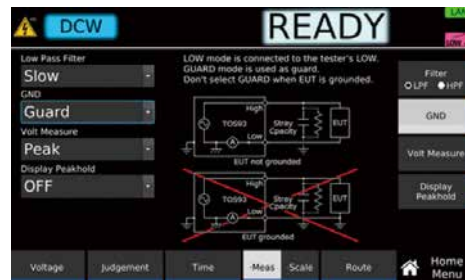

Offset Cancel

The Offset Cancel feature allows the user to eliminate electrical current found in the insulation resistance and stray capacitance among the output cables (only resistance for DC testing). This feature is available in all testing modes for AC withstanding voltage, DC withstanding voltage, insulation resistance, earth continuity and electrical current leakage tests.

Rise Time/Fall Time Control Function

The rise time control function prevents unnecessary stress from being applied to the EUT.

● Rise Time control function

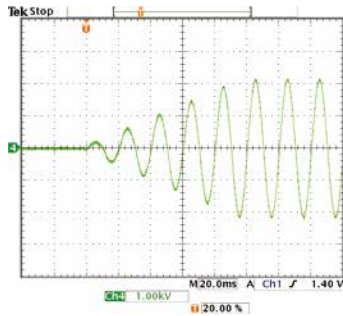

The rise time control feature allows you to gradually increase voltage to a set value while AC/DC hipot tests are conducted. Voltage rise times can be set from 0.1s to 200.0s at a resolution of 0.1s.

● Fall time control function

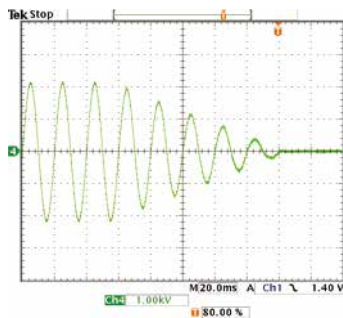

The fall time control feature allows you to gradually decrease the test voltage after a successful AC/DC hipot test. The voltage fall time can be set from 0s to 200s at a resolution of 0.1s. (OFF is also selectable).

Basic Memory Function

In addition to automatic testing memory functions, up to 51 basic setting conditions and testing modes can be selected and saved to the main unit or USB memory. Easy testing with no hassle!

"sda1" is the folder displayed when USB memory is inserted.

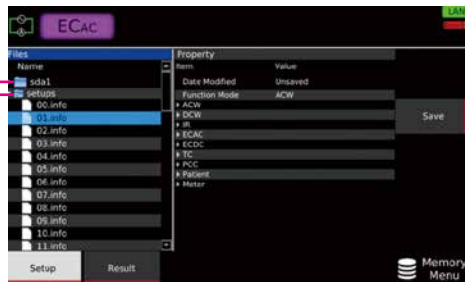

Testing conditions can be saved in 00-50 of "setups". (Total 51)

Calibration Deadline Notification

A real-time clock IC has been equipped to ensure that the instrument is traceable via regular calibration. The device will automatically generate warning notifications when the calibration deadline is exceeded.

Multi-Channel Testing System (Option)

The TOS9320 high voltage scanner allows for rapid distribution of testing voltage from the main unit to multiple testing points for withstanding voltage and insulation resistance testing. Channels can be controlled via an external device through the rear panel CONTROLLER INTERFACE connector. The scanner can also be used standalone or with an external control device for other Kikusui withstanding voltage and insulation resistance testing instruments. Hipot tests for electronic devices with multiple testing points have never been easier. (See Application P9)

[High-voltage scanner TOS9320]



▲Front panel



▲Rear panel

- Output can be expanded to four channels with one high-voltage scanner. The electric potential of each channel can be arbitrarily set to high, low, or open, and can be tested at any of these four points.
- Up to four high voltage scanners (total 16 channels) can be connected to each unit.
- Output of each channel and contact with testing points can be easily monitored.

[4 channel test system]

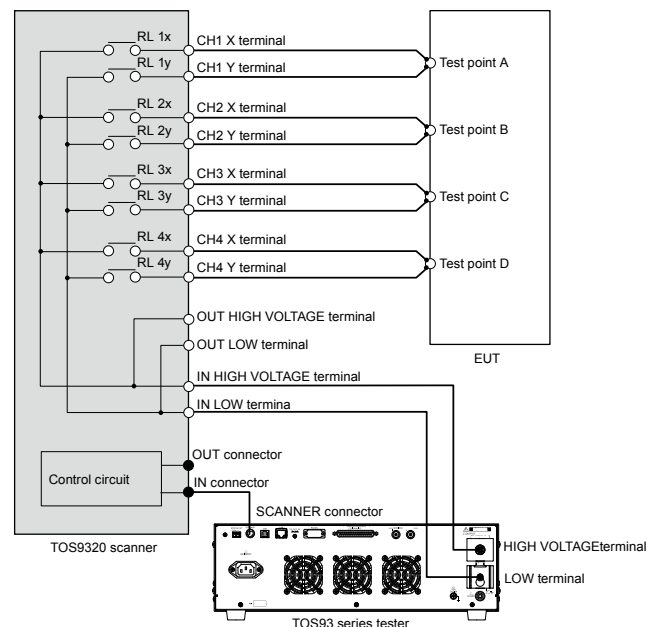

Application

Leakage Current Test

Compatible with medical device leakage current testing (patient current)! (TOS9303LC only)

● Test Example

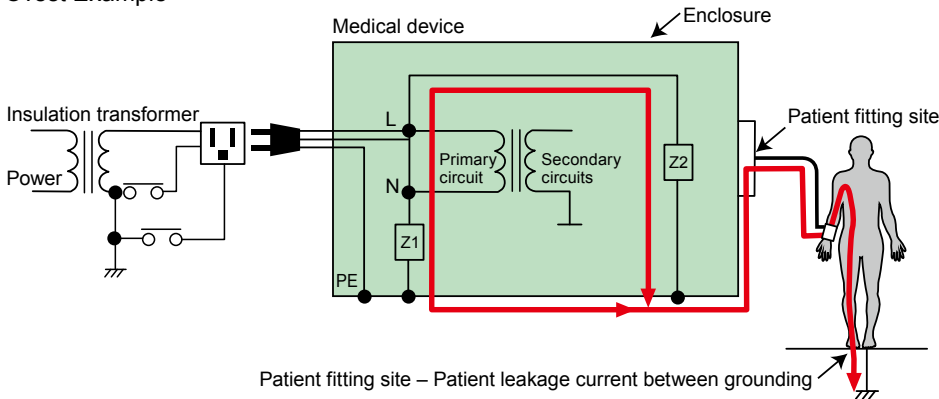

What is patient leakage current testing?

This test measures current flowing from the point of contact between a medical instrument and a simulated human body network to the ground. If the measurement does not exceed a value deemed harmful to a human being as defined in international safety standards, the product is considered safe and compliant to electric shock prevention requirements.

Easy Test Condition Programmability

Internal measurement circuit networks (I IEC60601-1) enable easily programmable test conditions.

*For details on other internally installed measurement circuit networks, see Specifications (P19).



▲TOS9303LC

Setting test conditions

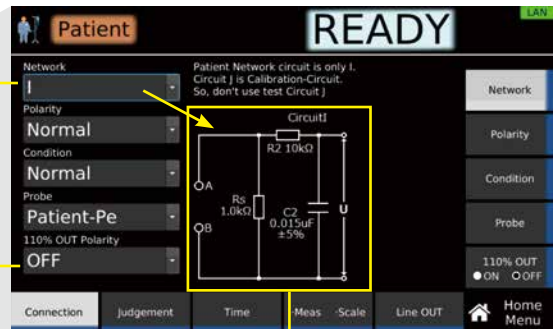

Measurement circuit network (network I IEC60601-1)

Electrical safety standard testing for automotive components

Compatible with both AC and DC, the TOS9303LC complies with a wide variety of safety tests for EV batteries, automotive charging devices and charging connectors. This "all-in-one" safety analyzer can meet the needs of nearly all automotive electrical safety standards.

All in One!

ACW DCW IR EC LC

IEC61851-21 etc.

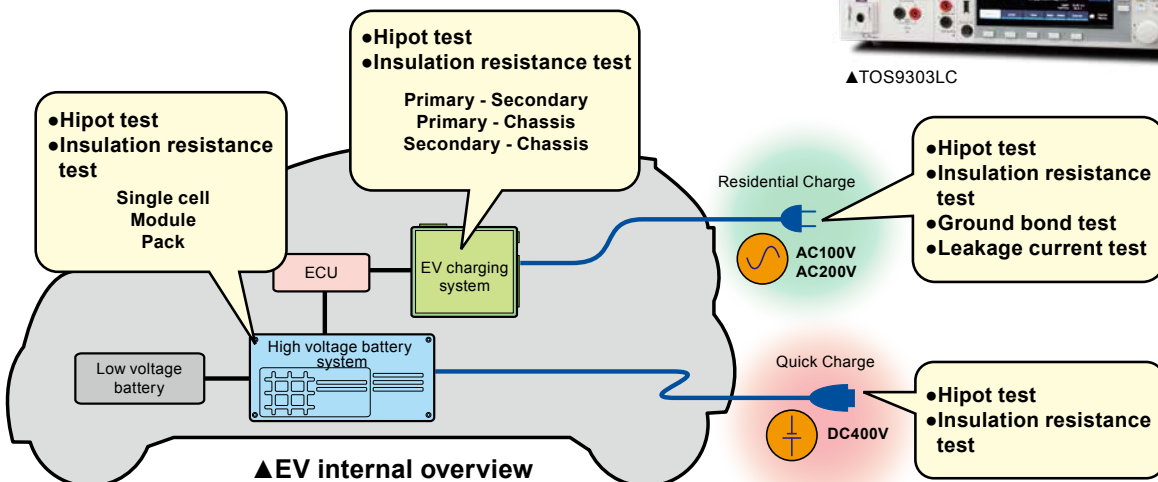

▲TOS9303LC

PV (solar battery) module withstanding voltage/insulation resistance testing

Withstanding voltage tests such as IEC61730-2 and JIS C 8992-2 require testing voltage to be drastically increased (4 times the maximum system voltage + 2000 V) and maintained for 1 minute.

[Voltage 1000 V adaptation grade A example]

$1000\text{ V} \times 4\text{-fold} + 2000\text{ V} = \text{Test voltage : } \mathbf{6000\text{ V}}$

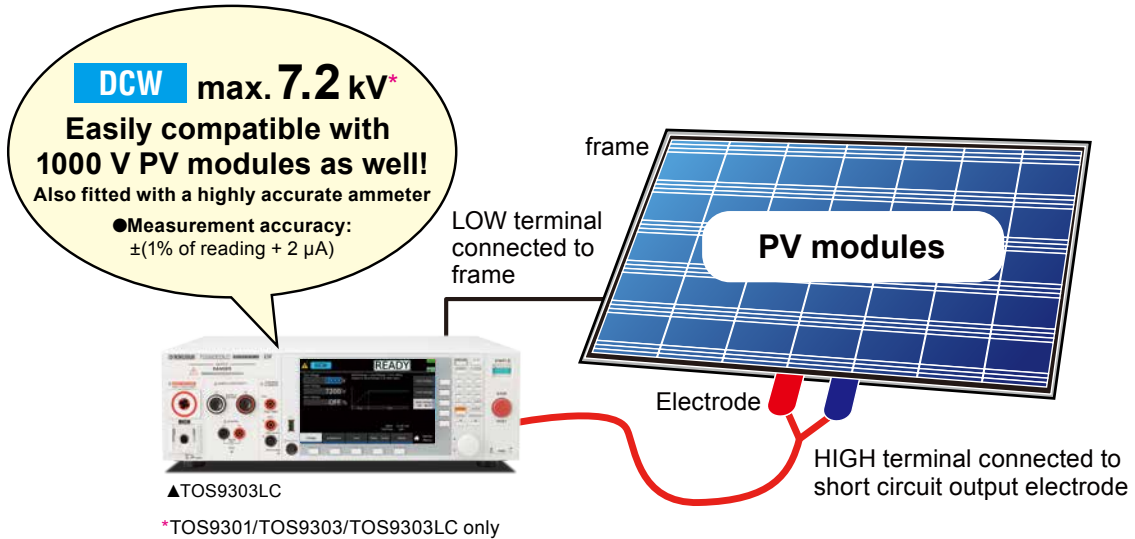

Multi-channel withstanding voltage/insulation resistance testing

Multiple testing points can be simultaneously tested to cut costs and save time!
 The TOS9320 high voltage scanner allows for multi channel expansion for the TOS9300 series as well as previous models.

[16CH Test system]

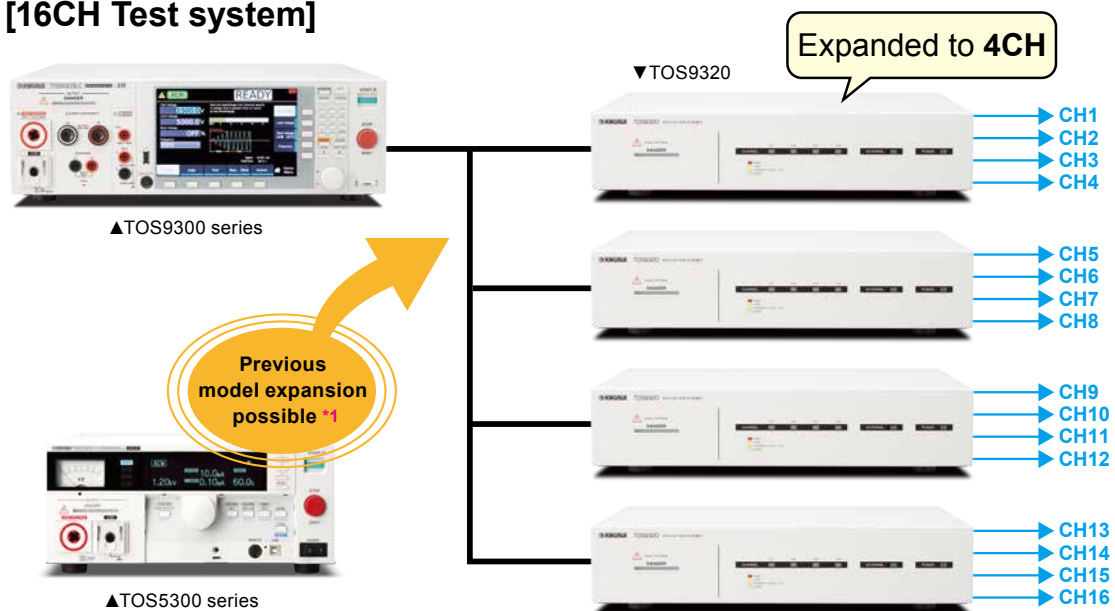

*1 Independent control of the scanner is required using EXTERNAL I / O.

* Mount on a rack when using two or more scanners.

Exterior Design

Front panel

●TOS9303LC

DANGER LED

Lights red when the power is turned on, when a test is in progress, when a high voltage is being output, or when there is residual voltage at the output terminals. On the TOS9303LC, the LED also lights red when supply voltage is being supplied to the EUT.

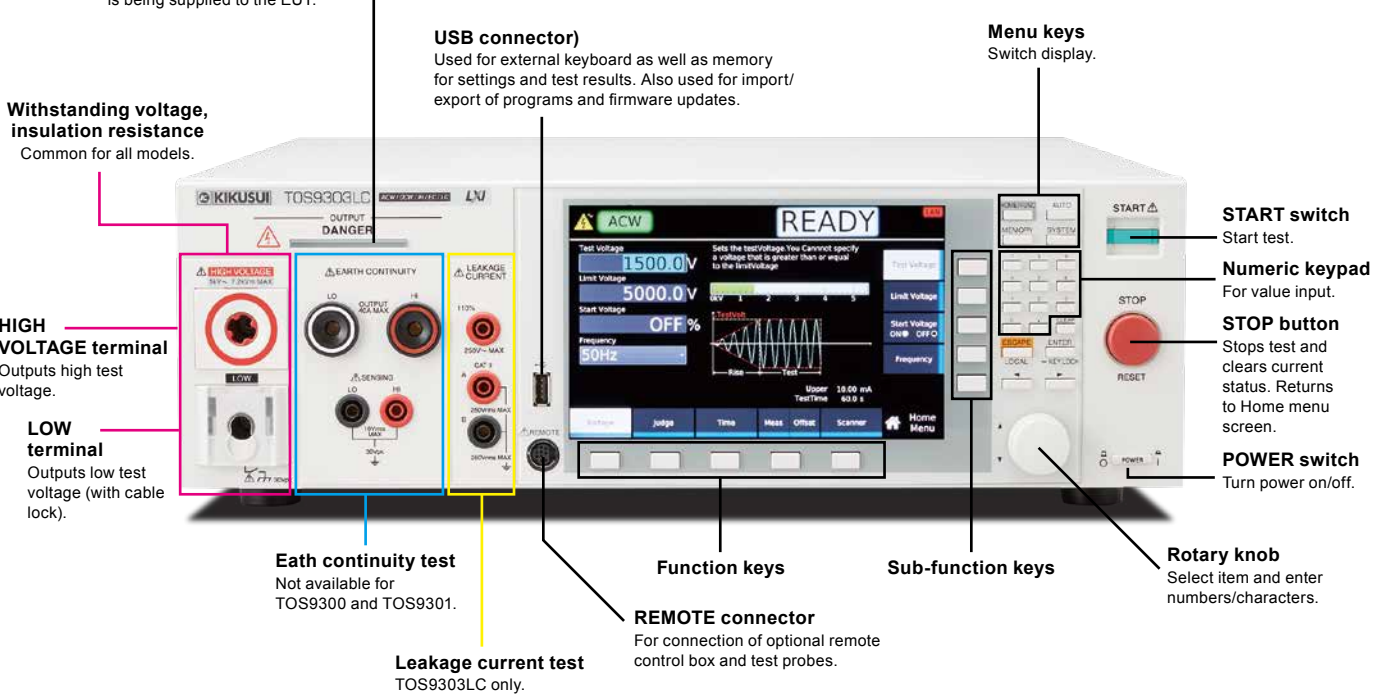

Rear panel

●TOS9303LC

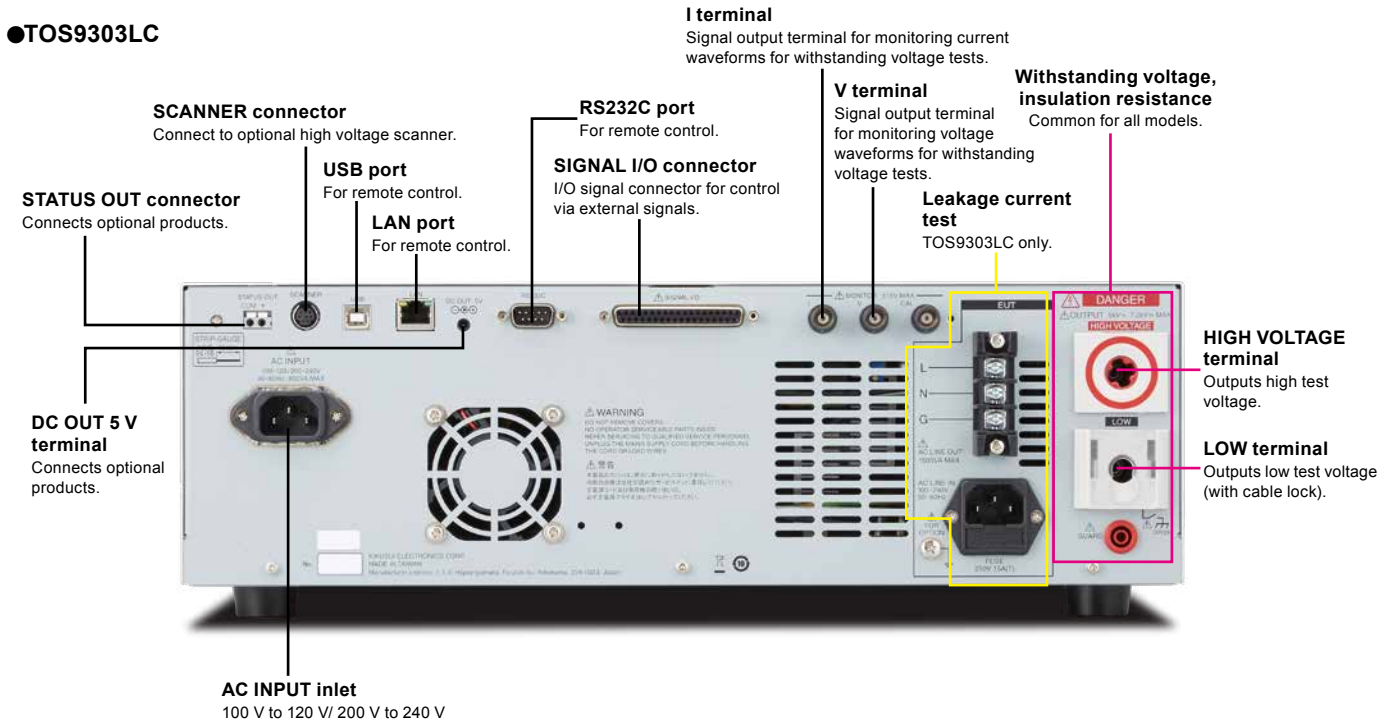

Display (Each menu screen)

●TOS9303LC screen example

Test mode
Select test type.

Test status

LAN connection status

Test condition setting

Home Menu
Set conditions for each test. Execute test.

Current menu screen
Press menu key to switch between menus.

The screenshot shows the 'ACW' test mode screen. At the top, it displays 'ACW' and 'READY'. The 'Test Voltage' is set to 1500V, 'Limit Voltage' to 3500V, 'Start Voltage' to 5%, and 'Frequency' to 60Hz. A progress bar for the limit voltage is visible. On the right, there are buttons for 'Test Voltage', 'Limit Voltage', 'Start Voltage', and 'Frequency'. At the bottom, there are buttons for 'Voltage', 'Judgement', 'Time', 'Meas', 'Scale', 'Route', and 'Home Menu'. The 'Home Menu' button is highlighted.

Test mode
Select test type.

Function Menu
Displays summary of settings for each test. Switch test modes.

The screenshot shows the 'Function Menu' screen. It lists various test modes: ACW, DCW, IR, ECAC, ECDC, TC, PCC, Patient, and Meter. Each mode has a corresponding icon and a summary of its settings, including Test Voltage, Test Current, Upper/Lower limits, and Test Time. At the bottom, there are buttons for 'ACW', 'DCW', 'IR', 'EC', and 'LC', along with a 'Function Menu' button.

Program Menu
Configure and execute auto tests.

The screenshot shows the 'Program Menu' screen. It displays a table of test programs with columns for Function, Start Level, Test Level, Judgment Upper, Judgment Lower, Judgment Delay, Pulse Time, Test Time, and Fail Time. The table lists several programs, including ACW, ECAC, ECDC, DCW, IR, TC, PCC, Patient, and Meter. At the bottom, there are buttons for '1.File', '2.Steps', '3.Execute', 'Export/Import', and 'Program Menu'.

Memory Menu
Use memory function.

The screenshot shows the 'Memory Menu' screen. It displays a list of memory settings, including '01.info', '02.info', '03.info', '04.info', '05.info', '06.info', '07.info', '08.info', '09.info', '10.info', '11.info', and '12.info'. Each item has a 'Property' column and a 'Value' column. At the bottom, there are buttons for 'Setup', 'Result', and 'Memory Menu'.

System Menu
Display and change system settings.

The screenshot shows the 'System Menu' screen. It displays various system settings, including 'KIKUSUI', 'Firmware Version', 'PC Version', 'FPGA Version', 'IOC Version', 'HDKS Hostname', and 'HDKS Service Name'. At the bottom, there are buttons for 'Configure', 'Interface', 'SCPI Error', 'Admin', 'Information', and 'System Menu'.

Specifications

- Unless specified otherwise, the specifications are for the following settings and conditions.
- The product is warmed up for at least 30 minutes.
- TYP: These are typical values that are representative of situations where the product operates in an environment with an ambient temperature of 23 °C. These values do not guarantee the performance of this product.
- setting: Indicates a setting. • range: Indicates the rated value of each range. • reading: Indicates a readout value.
- The various tests are abbreviated as follows: ACW: AC withstanding voltage, DCW: DC withstanding voltage, IR: insulation resistance, EC: earth continuity, LC: leakage current, TC: touch current, PCC: protective conductor current, Patient: patient leakage current, Meter: meter mode

■ Withstanding Voltage Test

[Output function]

Item	TOS9300	TOS9301	TOS9302	TOS9303	TOS9303LC
AC output section	Output range				
	Resolution				
	Setting accuracy				
	Max. rated load *1				
	Max. rated current				
	Transformer rating				
	Output voltage waveform *2				
	Distortion				
	Crest factor				
	Frequency				
	Accuracy				
	Voltage regulation				
Short-circuit current					
Output method					
Start voltage	The voltage at the start of the test can be set.				
	Setting range				
	Resolution				
Output voltage monitor function					
If the output voltage exceeds $\pm(10\%$ of setting + 50 V), the output is turned off, and the protection function is activated.					

[DC Output function]

Item	TOS9301	TOS9303	TOS9303LC
DC output section	Output voltage range		
	Resolution		
	Setting accuracy		
	Max. rated load *1		
	Max. rated current		
	Ripple		
	Max. rated load		
Start voltage	The voltage at the start of the test can be set.		
	Setting range		
	Resolution		
	Output voltage monitor function		
	If the output voltage exceeds $\pm(10\%$ of setting + 50 V), the output is turned off, and the protection function is activated.		

- *1 When tests are performed consecutively, output time limit and rest time may become necessary depending on the upper limit setting
- *2 If an AC voltage is applied to a capacitive load, the output voltage may rise higher than at no load depending on the load capacitance. Further, waveform distortions may occur if an EUT whose capacitance is dependent on voltage (for example, an EUT that consists of ceramic capacitors) is connected as the load. However, if the test voltage is 1.5 kV, the effect of a capacitance of 1 000 pF or less can be ignored. Because the product's high-voltage power supply uses the PWM switching method, if the test voltage is 500 V or less, the switching and spike noise proportions are large. The lower the test voltage, the greater the waveform is distorted.

[Measurement function]

Item	TOS9300	TOS9301	TOS9302	TOS9303	TOS9303LC
Voltmeter	Measurement range				
	Resolution				
	Accuracy				
	Response				
	Hold function				
Ammeter *1 *2	Measurement range				
	Accuracy				
	Response				
	Hold function				
	Offset cancel function				
Calibration					

- *1 During AC voltage tests, current also flows in the stray capacitance of items such as the test leads and tools. For details on stray capacitance, see "Stray Capacitance of AC Withstanding Voltage Tests"
- *2 When the temperature and humidity are high, erroneous current from the product's internal and external high-voltage wiring sections to ground increases. When the humidity exceeds 70 %, an erroneous current of about 50 μ A may be generated.

[Judgment function]

Item	TOS9300	TOS9301	TOS9302	TOS9303	TOS9303LC
Current judgment operation	The output is shut off when a judgment is made. Buzzer volume level can be set in the range of 0 (OFF) to 10 for pass and fail separately. In an auto test, the buzzer is valid only for the judgment that takes place at the end of the program.				
UPPER FAIL	Judgment method	UPPER FAIL results when a current greater than or equal to the Upper limit is detected. For DCW, judgment is not made during the judgment delay (Judge Delay).			
	Display	"U-FAIL" is displayed.			
	Buzzer	On			
LOWER FAIL	Judgment method	LOWER FAIL results when a current less than or equal to the Lower limit is detected. Judgment is not made during Voltage rise time or Voltage fall time of an ACW test.			
	Display	"L-FAIL" is displayed.			
	Buzzer	On			
PASS	Judgment method	PASS judgment is made if U-FAIL or L-FAIL has not occurred when the test time elapses.			
	Display	"PASS" is displayed.			
	Buzzer	On (fixed to 50 ms)			
Voltage rise rate judgment operation	Judgment method	Monitors the voltage rise rate during Voltage rise time. This is valid when Auto set-ting of the judgment delay (Delay Auto) is set to on and the output voltage is 200 V or more. The output is shut off when a judgment is made. Buzzer volume level can be set in the range of 0 (OFF) to 10 for pass and fail separately.			
	Display	When the voltage rise rate (dV/dt) is less than approx. 1 V/s, UPPER FAIL results.			
	Buzzer	ON			
Upper limit setting range	AC: 0.01 mA to 110.00 mA, DC: 0.01 mA to 21.00 mA				
Lower limit setting range	AC: 0.00 mA to 109.99 mA, DC: 0.00 mA to 20.99 mA, OFF. Setting 0.00 is equivalent to OFF.				
Judgment accuracy *1 *2	±(1 % of setting + 5 µA)				
Current detection method	Compares to the reference value using the following method. Calculate true rms values, convert mean-value responses to rms values				
Response speed (filter) switching	Switches the current detection response speed (sensitivity) used in UPPER FAIL judgment between five levels in ACW and DCW tests.				

*1 During AC voltage tests, current also flows in the stray capacitance of items such as the test leads and tools. For details on stray capacitance, see "Stray Capacitance of AC Withstanding Voltage Tests"

*2 When the temperature and humidity are high, erroneous current from the product's internal and external high-voltage wiring sections to ground increases. When the humidity exceeds 70 %, an erroneous current of about 50 µA may be generated.

[Timer function]

Item	TOS9300	TOS9301	TOS9302	TOS9303	TOS9303LC
Voltage rise time settings range	0.1 s to 200 s				
Voltage fall time setting time *1	0 s to 200s, OFF				
Test time setting range	0.1 s to 1000 s, OFF				
Judgment delay (Judge Delay) setting range *2	0.3 s to 10 s, AUTO *3 (DCW only)				
Accuracy	±(100 ppm of setting + 20 ms) (excluding the fall time)				

*1 This setting is used only when a PASS judgment occurs in ACW and DCW tests. During a DCW test, the voltage may not drop all the way within the set time because of the electrostatic capacity inside the product and the EUT.

*2 Less than the sum of the rise time and fall time.

*3 If Delay Auto is set to on, LOWER judgment is not made until the charge time ends.

[Other specifications]

Item	TOS9300	TOS9301	TOS9302	TOS9303	TOS9303LC
Analog monitor *1	Outputs a voltage signal according to the current waveform or voltage waveform				
	I	Current waveform: Scale 50 mA/1 V			
	V	Voltage waveform: Scale 1 kV/1 V			
Grounding mode (GND)	Can be switched between Low and Guard.				
	Low	GND is connected to the low terminal. Measures the current flowing across the low terminal and chassis (normal applications).			
	Guard *2	GND is connected to Guard. Measures only the current flowing through the low terminal (current flowing through the chassis is not measured) (high sensitivity, high accuracy measurement applications).			

*1 Monitor signal output is isolated from the chassis (earth). If you connect an oscilloscope or an external device whose BNC shield is grounded, be sure to set the grounding mode (GND) to Guard. The value is not calibrated.

*2 If there is a possibility that the EUT or tools and the like will be grounded or if you are uncertain, do not set GND to Guard. Doing so is extremely dangerous because the ammeter will be shorted and will not be able to measure current. For normal applications, set GND to Low.

Specifications

■ Insulation Resistance Test

[Output function]

Item		TOS9300	TOS9301	TOS9303	TOS9303LC	
Negative polarity	Output voltage range	-25 V to -1000 V				
		Resolution	1 V			
		Setting accuracy	±(1.2 % of setting + 2 V)			
	Max. rated load	1 W (-1000 V/1 mA)				
	Ripple	1 kV no load	2 Vp-p or less			
		Max. rated load	10 Vp-p or less			
Short-circuit current		12 mA or less				
Positive polarity *1	Output voltage range	-			+50 V to +7200 V	
					Resolution	1 V
					Setting accuracy	±(1.2 % of setting + 20 V)
	Max. rated load				7.2 W(7200 V/1 mA)	
	Ripple				1 kV no load	20 Vp-p or less
					Max. rated load	50 Vp-p or less
Short-circuit current		100 mA (TYP) (200 mA peak)				
Max. rated current		1 mA				
Voltage regulation		1 % or less (when changing from maximum rated load to no load)				
Discharge function		Forced discharge after test completion (discharge resistance: 20 kΩ)				
Output voltage monitor function		If the output voltage exceeds ±(10 % of setting + 50 V), the output is turned off, and the protection function is activated.				

*1 TOS9300 are not supported.

[Measurement function]

Item		TOS9300	TOS9301	TOS9303	TOS9303LC	
Voltmeter	Measurement range	Negative polarity: 0 Vdc to -1200 Vdc, positive polarity: 0 Vdc to 7500 Vdc				
	Resolution	0.1 V				
	Accuracy	Negative polarity: ±(1 % of reading + 1 V), positive polarity: ±(1.2 % of reading + 1 V)				
Resistance meter	Measurement range		0.001 MΩ to 100.0 GΩ (in the range of maximum rated current of 1 mA to 5 nA)			
	Accuracy *1 *2 (when GND is set to Guard) (i: measured current)(R: measurement resistance)	5 nA ≤ i ≤ 50 nA	500.0 mΩ ≤ R < 10.00 GΩ:	±(15 % of reading + 5 digit) *3		
			10.00 GΩ ≤ R ≤ 100.0 GΩ:	±(20 % of reading + 20 digit) *3		
		50 nA < i ≤ 100 nA	200.0 MΩ ≤ R < 50.00 GΩ:	±(10 % of reading + 5 digit) *3		
			50.00 GΩ ≤ R ≤ 100.0 GΩ:	±(20 % of reading + 20 digit) *3		
		100 nA < i ≤ 200 nA	100.0 MΩ ≤ R < 2.000 GΩ:	±(7 % of reading + 5 digit) *4		
			2.000 GΩ ≤ R < 50.00 GΩ:	±(7 % of reading + 10 digit) *4		
		200 nA < i ≤ 1 μA	10.00 MΩ ≤ R < 25.00 GΩ:	±(5 % of reading + 5 digit) *4		
			1 μA < i ≤ 1 mA	0.01 MΩ ≤ R < 5.000 GΩ:	±(2 % of reading + 3 digit) *4	
		Accuracy *5 (when GND is set to Low) (i: measured current)(R: measurement resistance)	5 nA ≤ i ≤ 50 nA	500.0 mΩ ≤ R < 10.00 GΩ:	±(25 % of reading + 5 digit) *3	
				10.00 GΩ ≤ R ≤ 100.0 GΩ:	±(30 % of reading + 20 digit) *3	
	50 nA < i ≤ 100 nA		200.0 MΩ ≤ R < 50.00 GΩ:	±(20 % of reading + 5 digit) *3		
			50.00 GΩ ≤ R ≤ 100.0 GΩ:	±(30 % of reading + 20 digit) *3		
	100 nA < i ≤ 200 nA		100.0 MΩ ≤ R < 2.000 GΩ:	±(10 % of reading + 5 digit) *4		
2.000 GΩ ≤ R < 50.00 GΩ:		±(10 % of reading + 10 digit) *4				
200 nA < i ≤ 1 μA	10.00 MΩ ≤ R < 25.00 GΩ:	±(5 % of reading + 5 digit) *4				
	1 μA < i ≤ 1 mA	0.01 MΩ ≤ R < 5.000 GΩ:	±(2 % of reading + 3 digit) *4			
Hold function		The resistance measurement after a test is finished is held while the pass judgment is displayed.				
Offset cancel function		Cancels up to 2000 GΩ of the unnecessary insulation resistance across output cables and the like. OFF function available.				

*1 Humidity: 70 %rh or less (no condensation), when there is no interference caused by wobbly test leads or other prob-lems.

*2 If the grounding mode (GND) is set to low in a highly humid environment, leakage current to ground will be generated from the high-voltage wiring sections inside the product and the high-voltage wiring sections between the product and the EUT. This leakage current ranges from several nA to several tens of nA depending on the usage and wiring conditions of the optional TOS9320 high voltage scanner and greatly affects measurement accuracy. The effects of leakage current can be reduced by making measurements with the offset enabled.

*3 Add 10 % to the accuracy when measuring 100 V or less.

*4 Add 5 % to the accuracy when measuring 100 V or less.

*5 When the measured current is limited to 100 nA or more (no condensation) when the humidity is 50 %rh or less, no external disturbance is present such as swinging test leads, and the offset is enabled.

Judgment function

Item	TOS9300	TOS9301	TOS9303	TOS9303LC
Behavior based on judgment	The output is shut off when a judgment is made. Buzzer volume level can be set in the range of 0 (OFF) to 10 for pass and fail separately. In an auto test, the buzzer is valid only for the judgment that takes place at the end of the program.			
UPPER FAIL	Judgment method	UPPER FAIL results when a resistance greater than or equal to the Upper limit is detected. Judgment is not made during or Voltage rise time.		
	Display	"U-FAIL" is displayed.		
	Buzzer	On		
	SIGNAL I/O	The U-FAIL signal is generated continuously until a STOP signal is received.		
LOWER FAIL	Judgment method	LOWER FAIL results when a resistance less than or equal to the Lower limit is detected. Judgment is not made during the judgment delay (Judge Delay).		
	Display	"L-FAIL" is displayed.		
	Buzzer	On		
PASS	SIGNAL I/O	The L-FAIL signal is generated continuously until a STOP signal is received.		
	Judgment method	PASS judgment is made if U-FAIL or L-FAIL has not occurred when the test time elapses.		
	Display	"PASS" is displayed.		
	Buzzer	On (fixed to 50 ms)		
Voltage rise rate judgment operation	SIGNAL I/O	The PASS signal is generated for the length of time specified by the Pass Hold setting. If Pass Hold is set to Infinity, the PASS signal is generated continuously until a STOP signal is received.		
	Judgment method	Monitors the voltage rise rate during Voltage rise time. This is valid when Auto setting of the judgment delay (Delay Auto) is set to on and the output voltage is 200 V or more. The output is shut off when a judgment is made. Buzzer volume level can be set in the range of 0 (OFF) to 10 for pass and fail separately.		
	Display	When the voltage rise rate (dV/dt) is less than approx. 1 V/s, UPPER FAIL results.		
	Buzzer	On		
UPPER FAIL	SIGNAL I/O	The L FAIL signals are generated continuously until a STOP signal is received.		
	Display	"L-FAIL" is displayed.		
	Buzzer	On		
	Judgment method	When the voltage rise rate (dV/dt) is less than approx. 1 V/s, UPPER FAIL results.		
Upper limit setting range	0.001 MΩ to 100.000 GΩ (in the range up to the maximum rated current), OFF			
Lower limit setting range	0.000 MΩ to 99.999 GΩ (in the range up to the maximum rated current), OFF. Setting 0.000 is equivalent to OFF.			
Accuracy *1 (i: measured current) (R: measurement resistance)	5 nA ≤ i ≤ 50 nA	500.0 mΩ ≤ R < 10.00 GΩ: ±(15 % of setting + 15 digit) 10.00 GΩ ≤ R < 100.0 GΩ: ±(20 % of setting + 30 digit)		
	50 nA < i ≤ 100 nA	200.0 MΩ ≤ R < 50.00 GΩ: ±(10 % of setting + 15 digit) 50.00 GΩ ≤ R < 100.0 GΩ: ±(20 % of setting + 30 digit)		
	100 nA < i ≤ 200 nA	100.0 MΩ ≤ R < 2.000 GΩ: ±(7 % of setting + 15 digit) 2.000 GΩ ≤ R < 50.00 GΩ: ±(7 % of setting + 20 digit)		
	200 nA < i ≤ 1 μA	10.00 MΩ ≤ R < 25.00 GΩ: ±(5 % of setting + 15 digit)		
	1 μA < i ≤ 1 mA	0.01 MΩ ≤ R < 5.000 GΩ: ±(2 % of setting + 13 digit)		

*1 Making judgments on 200 μA or less requires at least 3 seconds after the rise time ends. Making judgments when the low pass filter is set to on requires at least 10 seconds after the rise time ends.

Timer function

Item	TOS9300	TOS9301	TOS9303	TOS9303LC
Voltage rise time settings range	0.1 s to 200 s			
Test time setting range	0.5 s to 1000 s, OFF			
Judgment delay (Judge Delay) setting range *1	0.1 s to 10 s, AUTO *2			
Accuracy *3	±(100 ppm of setting + 20 ms)			

*1 Less than the sum of the rise time and fall time.

*2 If Delay Auto is set to on, UPPER judgment is not made until the charge time ends.

*3 This excludes fall time.

Other specifications

Item	TOS9300	TOS9301	TOS9303	TOS9303LC
Grounding mode (GND)	Can be switched between Low and Guard.			
	Low	GND is connected to the low terminal. Measures the current flowing across the low terminal and chassis (normal applications).		
	Guard *1	GND is connected to Guard. Measures only the current flowing through the low terminal (current flowing through the chassis is not measured) (high sensitivity, high accuracy measurement applications).		
Filter function	A low-pass filter can be inserted into the ammeter measurement circuit. *2			

*1 If there is a possibility that the EUT or tools and the like will be grounded or if you are uncertain, do not set GND to Guard. Doing so is extremely dangerous because the ammeter will be shorted and will not be able to measure current. For normal applications, set GND to Low.

*2 When the low pass filter is on, a judgment delay of at least 5 seconds and a test time are required.

Specifications

■ Earth Continuity Test

[Output function]

Item		TOS9302	TOS9303	TOS9303LC
		3.0 A to 42.0 A AC/DC		
Current setting range *1	Resolution	0.1 A		
	Accuracy	±(1 % of setting + 0.4 A)		
AC	Maximum rated output *2	220 VA (at the output terminal)		
	Distortion	2 % or less (20 A or more, using a 0.1 Ω pure resistive load)		
	Frequency	Select 50 Hz or 60 Hz. Sine		
		Accuracy	±200 ppm	
	Open terminal voltage	6 Vrms or less		
Output method	PWM switching			
DC	Maximum rated output	220 W (at the output terminal)		
	Ripple	±0.4 Ap-p or less (TYP)		
	Open terminal voltage	6.0 V or less		

*1 No greater than the maximum rated output and resistance no greater than the output terminal voltage 5.4 V.

*2 When tests are performed consecutively, output time limit and rest time may become necessary depending on the up-per limit setting.

[Measurement function]

Item		TOS9302	TOS9303	TOS9303LC
Output ammeter	Measurement range	0.0 A to 45.0 A AC/DC		
	Resolution	0.1 A		
	Accuracy	±(1 % of reading + 0.2 A)		
	Response	AC: true rms value; DC: mean value		
	Hold function	The current measurement after a test is finished is held while the pass or fail judgment is displayed.		
Output voltmeter	Measurement range	AC: 0.00 V to 6.00 V, DC: 0.00 V to 8.50 V		
	Resolution	0.01 V		
	Offset cancel function	Cancels up to 5 V (AC/DC) of the unnecessary voltage from measurements. OFF function available.		
	Accuracy	±(1 % of setting + 0.02 V)		
	Response	AC: true rms value; DC: mean value		
Resistance meter	Hold function	The voltage measurement after a test is finished is held while the pass or fail judgment is displayed.		
	Measurement range *1	0.001 Ω to 0.600 Ω		
	Resolution	0.001 Ω		
	Offset cancel function	Cancels up to 10 Ω of the unnecessary resistance from measurements. OFF function available.		
	Accuracy	±(2 % of reading + 0.003 Ω)		
Hold function	The resistance measurement after a test is finished is held while the pass judgment is displayed.			

*1 Calculated from the measured output voltage and measured output current.

[Judgment function]

Item		TOS9302	TOS9303	TOS9303LC
Behavior based on judgment	UPPER FAIL	Judgment method	Judgment based on resistance or sensing voltage can be selected. The output is shut off when a judgment is made. Buzzer volume level can be set in the range of 0 (OFF) to 10 for pass and fail separately. In an auto test, the buzzer is valid only for the judgment that takes place at the end of the program.	
		Display	UPPER FAIL results when a resistance greater than or equal to the Upper limit is detected or when a sensing voltage is detected. Judgment is not made during a contact check.	
		Buzzer	"U-FAIL" is displayed.	
		SIGNAL I/O	On	
	LOWER FAIL	Judgment method	The U-FAIL signal is generated continuously until a STOP signal is received.	
		Display	LOWER FAIL results when a resistance less than or equal to the lower limit (Lower) is detected or when a sensing voltage is detected.	
		Buzzer	"L-FAIL" is displayed.	
		SIGNAL I/O	On	
	PASS	Judgment method	The L-FAIL signal is generated continuously until a STOP signal is received.	
		Display	PASS judgment is made if U-FAIL or L-FAIL has not occurred when the test time elapses.	
		Buzzer	"PASS" is displayed.	
		SIGNAL I/O	On (fixed to 50 ms)	
Resistance judgment	Upper limit setting range	The PASS signal is generated for the length of time specified by the Pass Hold setting. If Pass Hold is set to Infinity, the PASS signal is generated continuously until a STOP signal is received.		
	Lower limit setting range	0.0001 Ω to 10.0000 Ω		
	Judgment accuracy	0.0000 Ω to 9.9999 Ω		
Voltage judgment	Upper limit setting range	±(2 % of UPPER + 0.003 Ω)		
	Lower limit setting range	0.001 V to 5.000 V AC/DC		
	Judgment accuracy	0.000 V to 4.999 V AC/DC		
Calibration	±(2 % of UPPER + 0.05 V)			
Contact check function	Calibrated using a pure resistive load (with the rms of a sine wave for AC)			
Checks that current flows through the test leads and then starts the test. (OFF setting available)				

[Timer function]

Item	TOS9302	TOS9303	TOS9303LC
Voltage rise time settings range	0.1 s to 200 s		
Voltage fall time setting time *1	0.1 s to 200 s, OFF		
Test time	0.3 s to 1000 s, OFF		
Accuracy	±(100 ppm of setting + 20 ms) (excluding the fall time)		

*1 This setting is used only when a PASS judgment occurs. During a DC test, the voltage may not drop all the way within the set time because of the electrostatic capacity inside the product and the EUT.

Specifications

Leakage Current Test

[Measurement function]

Item		TOS9303LC		
Measurement Item	TC	Touch current measurement		
		Measurement mode		
		Probe settings	Enc - Pe	A terminal: measurement terminal (for connecting to the enclosure of the EUT) B terminal: open
			Enc - Enc	A and B terminals: measurement terminal (for connecting to the enclosure of the EUT)
	Enc - Liv Enc - Neu		A terminal: measurement terminal (for connecting to the enclosure of the EUT) B terminal: open	
	PCC	Protective conductor current measurement		
		Measurement method		
		Patient leakage current measurement		
	Patient	Measurement method		
		Measures the current flowing or voltage applied across the A and B terminals (simultaneous measurement not possible).		
Meter	Measurement method	Current measurement	Uses a measurement circuit network representing the impedance of a human body and measures the voltage drop across a reference resistance to calculate the current flowing across the A and B terminals.	
		Voltage measurement	Measures the voltage applied across the A and B terminals.	
		DC	Eliminates AC components and measures only the DC component.	
Current measurement mode		RMS	Measures the true rms value (switch AC and AC+DC)	
		Peak *1	Measures waveform peak values	

*1 Current measurements may not be stable due to the effects of the power supply line waveform or the wiring environment between the product and the EUT.

[Measurement circuit network]

Item		TOS9303LC	
Network	A (IEC 60990 compliant) *1	(1.5 kΩ // 0.22 μF) + 500 Ω, reference measurement element: 500 Ω	
	B (IEC 60990 compliant)	(1.5 kΩ // 0.22 μF) + 500 Ω // (10 kΩ + 22 nF), reference measurement element: 500 Ω, voltage measurement U1 and U3 switchable	
	C (IEC 60990 compliant)	(1.5 kΩ // 0.22 μF) + 500 Ω // (10 kΩ + (20 kΩ + 6.2 nF) // 9.1 nF), reference measurement element: 500 Ω, voltage measurement U1 and U3 switchable	
	D (Electrical Appliances and Materials Safety Act, etc.)	1 kΩ, reference measurement element: 1 kΩ	
	E (Electrical Appliances and Materials Safety Act)	1 kΩ // (10 kΩ + 11.225 nF + 579 Ω), reference measurement element: 1kΩ	
	F (UL and the like)	1.5 kΩ // 0.15 μF, reference measurement element: 1.5 kΩ	
	G	2 kΩ, reference measurement element: 2 kΩ	
	H (IEC 61010-1, 60601-1wet)	375 Ω // 0.22 μF + 500 Ω, reference measurement element: 500 Ω	
	I (Patient)	1 kΩ // 10 kΩ + 0.015 μF, reference measurement element: 1 kΩ	
	J (through)	For voltmeter calibration	
	PCC-1	150 Ω, reference measurement element: 150 Ω	
	PCC-2 (IEC 60598-1)	150 Ω // 1.5 μF, reference measurement element: 150 Ω	
Network constant tolerance		Resistance: ±0.1 %, capacitor 0.15 μF: ±2 %, others: ±1 %	
Network accuracy	A, B, C, H	Input voltage vs. output voltage ratio: logical value ± 5 % (according to IEC 60990 Annex L and F)	
	E	Input voltage vs. output voltage ratio: logical value ± 5 %	
	D, G	Reference measurement element (resistance) ± 1 %	
	I	Input voltage vs. output voltage ratio: logical value ± 5 %	

*1 Current measurements may not be stable due to the effects of the power supply line waveform or the wiring environment between the product and the EUT.

- Measurement circuit network
(NetworkA IEC 60990 Fig. 3 U1 measurement)

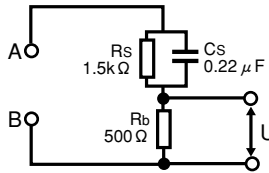

- Measurement circuit network
(NetworkB-U1 IEC 60990 Fig. 4 U2 measurement)

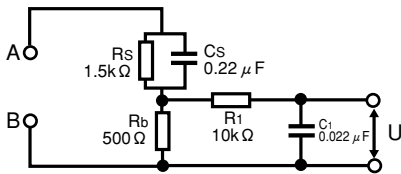

- Measurement circuit network
(NetworkB-U2 IEC 60990 Fig. 4 U1 measurement)

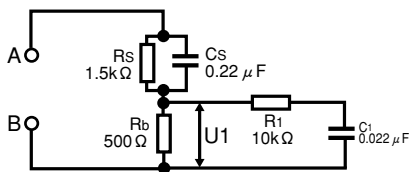

- Measurement circuit network
(NetworkC IEC 60990 Fig. 5 U3 measurement)

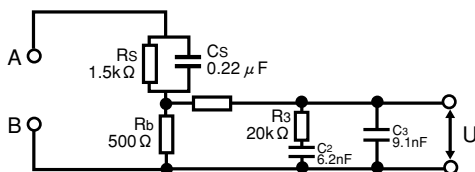

- Measurement circuit network
(NetworkD Electrical Appliances and
Materials Safety Act single frequency)

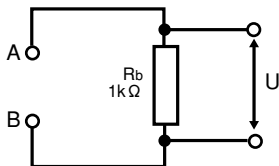

- Measurement circuit network
(NetworkE Electrical Appliances and
Materials Safety Act multiple frequencies)

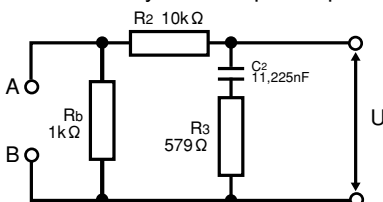

- Measurement circuit network
(NetworkF IEC 61029, UL)

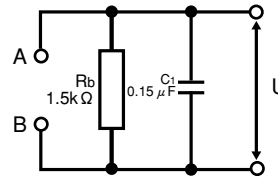

- Measurement circuit network
(NetworkG IEC 60745)

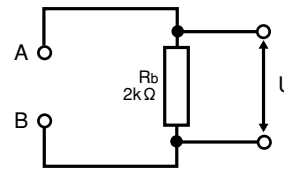

- Measurement circuit network
(NetworkI IEC 60601-1)

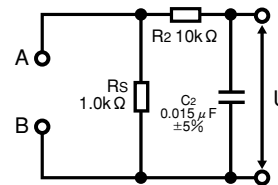

- Measurement circuit network
(NetworkPCC-1)

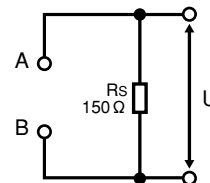

- Measurement circuit network
(NetworkPCC-2 IEC60598-1)

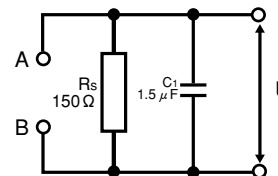

Specifications

[Measurement section]

Item		TOS9303LC		
Measured current display (I: measured current) (□: measurement display)	I < 100 μA	□□.□□ μA, resolution 0.01 μA		
	100 μA ≤ I < 1 mA	□□□.□ μA, resolution 0.1 μA		
	1 mA ≤ I < 10 mA	□.□□□ mA, resolution 0.001 mA		
	10 mA ≤ I < 100 mA	□□.□□ mA, resolution 0.01 mA		
Measurement range *1	Range 1	DC, RMS: 1 μA(min.) to 200 μA(max), Peak: 1 μA(min.) to 282 μA(max)		
	Range 2	DC, RMS: 12.5 μA(min.) to 2.00 mA(max), Peak: 17.5 μA(min.) to 2.83 mA(max)		
	Range 3	DC, RMS: 125 μA(min.) to 20.00 mA(max), Peak: 175 μA(min.) to 28.3 mA(max)		
	Range 4	DC, RMS: 1.25 mA(min.) to 100 mA(max), Peak: 1.75 mA(min.) to 100 mA(max)		
	Range switching	Auto or Fix selectable. If a measurement falls outside the measurement range of each range, the measured value blinks as a warning.		
	Auto	The range is set automatically according to the measurements.		
	Fix	For TC and PCC measurements, the measurement range is selected automatically according to the UPPER value. For meter measurements, the range is fixed to the specified range.		
	Bandwidth switching	Can be expanded to a bandwidth that allows measurements from 0.1 Hz, which is required in the measurement of medical instruments and the like.		
	Normal	Normal measurement bandwidth: 15 Hz to 1 MHz		
	Expand	Expands the measurement range to 0.1 Hz to 1 MHz		
Total accuracy *2 (when network A, B, or C is used) *3	Range 1	DC	±(5.0 % of reading + 2 μA)	
		RMS	0.1 Hz ≤ f < 15 Hz	±(10.0 % of reading + 2 μA)
			15 Hz ≤ f ≤ 100 kHz	±(7.0 % of reading + 2 μA)
			100 kHz < f ≤ 1 MHz	±(10.0 % of reading + 2 μA)
		Peak	0.1 Hz ≤ f < 15 Hz	±(10.0 % of reading + 10 μA)
			15 Hz ≤ f ≤ 1 kHz	±(10.0 % of reading + 10 μA)
			1 kHz < f ≤ 100 kHz	±(10.0 % of reading + 10 μA)
			100 kHz < f ≤ 1 MHz	±(20.0 % of reading + 10 μA)
			Range 2	DC
	RMS			0.1 Hz ≤ f < 15 Hz
		15 Hz ≤ f ≤ 100 kHz		±(7.0 % of reading + 8 μA)
		100 kHz < f ≤ 1 MHz		±(10.0 % of reading + 10 μA)
	Peak	0.1 Hz ≤ f < 15 Hz		±(10.0 % of reading + 10 μA)
		15 Hz ≤ f ≤ 1 kHz		±(10.0 % of reading + 10 μA)
		1 kHz < f ≤ 100 kHz	±(10.0 % of reading + 10 μA)	
	Range 3	DC	±(5.0 % of reading + 50 μA)	
		RMS	0.1 Hz ≤ f < 15 Hz	±(10.0 % of reading + 20 μA)
			15 Hz ≤ f ≤ 100 kHz	±(7.0 % of reading + 20 μA)
			100 kHz < f ≤ 1 MHz	±(10.0 % of reading + 20 μA)
		Peak	0.1 Hz ≤ f < 15 Hz	±(10.0 % of reading + 50 μA)
			15 Hz ≤ f ≤ 1 kHz	±(7.0 % of reading + 50 μA)
			1 kHz < f ≤ 100 kHz	±(10.0 % of reading + 50 μA)
			100 kHz < f ≤ 1 MHz	±(20.0 % of reading + 50 μA)
			Range 4	DC
	RMS			0.1 Hz ≤ f < 15 Hz
		15 Hz ≤ f ≤ 100 kHz		±(7.0 % of reading + 0.2 mA)
		100 kHz < f ≤ 1 MHz		±(10.0 % of reading + 0.2 mA)
	Peak	0.1 Hz ≤ f < 15 Hz		±(10.0 % of reading + 0.5 mA)
15 Hz ≤ f ≤ 1 kHz		±(7.0 % of reading + 0.5 mA)		
1 kHz < f ≤ 100 kHz		±(10.0 % of reading + 0.5 mA)		
100 kHz < f ≤ 1 MHz		±(20.0 % of reading + 0.5 mA)		
Input resistance		1 MΩ ± 1 %		
Input capacitance		200 pF or less (internal voltmeter input capacitance: 100 pF or less)		
Common mode rejection ratio	10 kHz or less: 60 dB or more, 10 kHz to 1 MHz: 40 dB or more			
Offset cancel function	Cancels up to 10 mA of the unnecessary current from measurements. OFF function available.			

*1 Voltmeter band expansion is possible when network I is selected.

*2 0.1 Hz ≤ f < 15 Hz is for when voltmeter band expansion (VoltMeter BandWidth) is set to Expand. Requires at least 120 second of test time.

*3 A value converted to current for measurements using Network A, B, C or H with voltmeter accuracy of this product as the reference.

If a network other than A, B, C or H is used, calculate as follows:

For Network D, E, or I, the ■ part of ±(□% of reading + ■A) is half the value.

For F, the ■ part is one-third the value.

For G, the ■ part is one-fourth the value.

For PCC-1 or PCC-2, the ■ part is 3.3 times the value.

[Judgment function]

Item		TOS9303LC	
		Judgment starts after the judgment delay (Judge Delay). Buzzer volume level can be set in the range of 0 (OFF) to 10 for pass and fail separately. In an auto test, the buzzer is valid only for the judgment that takes place at the end of the program.	
Behavior based on judgment	UPPER FAIL	Judgment method	UPPER FAIL results when a current greater than or equal to the upper limit (Upper) is detected.
		Display	"U-FAIL" is displayed.
		Buzzer	On
		SIGNAL I/O	The U-FAIL signal is generated continuously until a STOP signal is received.
	LOWER FAIL	Judgment method	LOWER FAIL results when a current less than or equal to the lower limit (Lower) is detected.
		Display	"L-FAIL" is displayed.
		Buzzer	On
		SIGNAL I/O	The L-FAIL signal is generated continuously until a STOP signal is received.
	PASS	Judgment method	PASS judgment is made if U-FAIL or L-FAIL has not occurred when the test time elapses.
		Display	"PASS" is displayed.
Buzzer		On (fixed to 50 ms)	
SIGNAL I/O		The PASS signal is generated for the length of time specified by the Pass Hold setting. If Pass Hold is set to Infinity, the PASS signal is generated continuously until a STOP signal is received.	
Upper Setting range	RANGE 1	DC, RMS: 0.1 μ A(min.) to 200 μ A(max), Peak: 0.1 μ A(min.) to 282 μ A(max)	
	RANGE 2	DC, RMS: 15.1 μ A(min.) to 2.00 mA(max), Peak: 21.3 μ A(min.) to 2.83 mA(max)	
	RANGE 3	DC, RMS: 151 μ A(min.) to 20.00 mA(max), Peak: 213 μ A(min.) to 28.3 mA(max)	
	RANGE 4	DC, RMS: 1.51 mA(min.) to 100 mA(max), Peak: 2.13 mA(min.) to 100 mA(max)	
Lower Setting range		A value that is -1 digit from the upper setting range.	
Judgment accuracy		Conforms to total accuracy(Read "reading" as "upper setting" of total accuracy.)	

[Timer function]

Item		TOS9303LC	
Judgment delay (Judge Delay)	Setting range	1 s to 1000 s, AUTO	
	Accuracy	\pm (100 ppm of setting + 20 ms)	
Test time	Setting range	1 s to 1000 s, OFF	
	Accuracy	\pm (100 ppm of setting + 20 ms)	

[Other specifications]

Item		TOS9303LC		
Voltage conversion			Displays the estimated current converted with the preset supply voltage (Conv Voltage), based on the voltage supplied to the EUT and the measured current. (This is invalid in meter mode.)	
	Setting range	80.0 V to 300.0 V, OFF		
	Resolution	0.1 V		
Power supply line polarity selection		Set the polarity of the power supply line to supply to the EUT to positive or negative.		
Single fault mode (Condition) selection		Set the EUT single fault mode to normal, neutral line disconnection (Fault Neu), or protective ground wire disconnection (Fault PE).		
Ground check		In the touch current test between the enclosure and power supply line, if the EUT enclosure is grounded, CONTACT FAIL occurs.		
Measurement check		Checks the measurement function by shorting across the A and B terminals. If an error is found, the protection function is activated.		
Supply voltage measurement AC LINE (EUT)	Measurement range	80.0 V to 250.0 V		
	Resolution	0.1 V		
	Accuracy	\pm (3 % of reading + 1 V)		
Supply current measurement AC LINE (EUT)	Measurement range	0.1 A to 15.00 A		
	Resolution	0.01 A		
	Accuracy	\pm (5 % of reading + 30 mA)		
Power measurement(active power)	Measurement range	10 W to 1500 W		
	Accuracy	\pm (5 % of reading + 8 W) (with the supply voltage at 80 V or more, at a load power factor of 1)		
Voltage measurement across the A and B terminals	Measurement range	DC	10.00 V to 300.0 V	
		RMS	10.00 V to 300.0 V	
		Peak	15.00 V to 430.0 V	
		Input impedance	Approx. 40 M Ω	
	Accuracy *1	\pm (3 % of reading + 2 V) (measurement range fixed to AUTO)		
	SELV detection			Set a voltage for detecting SELV. When the value is exceeded, the DANGER LED lights.
		Setting range	10 V to 99 V, OFF	
Resolution		1 V		
Measurement terminal	Rated voltage	Between the A and B terminals	250 V	
		Between the terminals and chassis	250 V	
	Rated current	100 mA		
	Measurement category	CAT-II		
	Valid terminal display	Terminals valid for measurement are indicated on the display.		
Power supply for the EUT	110% terminal	Terminal for supplying 110% voltage of the AC line.		
	Nominal voltage range	100 V to 240 V, 50 Hz/60 Hz		
	Input voltage range (allowable voltage range)	85 Vac to 250 Vac		
	Rated output capacity	1500 VA		
	Maximum operating current	15 A (Overcurrent protection is activated at approximately 15.75 A.)		
Inrush current	70 Apeak max. (within 20 ms)			

*1 If voltage is measured with the A and B terminals open, measurements will be easily affected by induced voltage.

Specifications

■ Interface (Common)

Item	TOS9300	TOS9301	TOS9302	TOS9303	TOS9303LC
REMOTE	5-pin DIN connector. Connect the following option to remotely control the starting and stopping of tests. <ul style="list-style-type: none"> Remote control box RC01-TOS, RC02-TOS High voltage test probe HP01A-TOS, HP02A-TOS (when the test voltage is 4 kVac 5 kVdc or less) 				
SIGNAL I/O	D-sub 37-pin connector. For the pin arrangement				
Function	Enable/disable interlock, recall setup memories, recall auto test programs, start/stop testing, monitor the test and voltage generation status, monitor the test status, monitor judgment results, monitor the step execution status of auto tests, monitor the activation status of protection functions				
	Input specifications				
	High-level input voltage	11 V to 15 V			
	Low-level input voltage	0 V to 4 V			
	Low-level input current	-5 mA max.			
	Input time width	5 ms min.			
	Output specifications				
	Output method	Open collector output (4.5 Vdc to 30 Vdc)			
Output withstanding voltage	30 Vdc				
Output saturation voltage	Approx. 1.1 V (25 °C)				
Maximum output current	400 mA(TOTAL)				
STATUS OUT	Output terminal of an option product.				
Positive terminal (red)	Outputs +24 V. Use Status Out of CONFIG settings to set the output conditions.				
Negative terminal (black)	+24 V circuit common.				
SCANNER	MINI DIN 8-pin connector. Terminal for the optional TOS9320 high voltage scanner. The maximum number of connections is 4 devices(16 channels).				
USB (host)	Standard type A socket, FAT32, 32 GB or less Complies with the USB 2.0 specifications; data rate: 12 Mbps (full speed)				
Remote control	All functions except turning on and off the power, key lock, and auto test can be remotely controlled.				
RS232C	Hardware	D-sub 9-pin connector (EIA-232D compliant) Baudrate: 9600, 19200, 38400, 57600, 115200 bps Data length: 8 bits; stop bits: 1 bit; parity bit: none, flow control: none/CTS-RTS			
	Message terminator	LF during reception, LF during transmission.			
USB (device)	Hardware	Standard Type B connector. Complies with the USB 2.0 specifications; data rate: 480 Mbps (high speed)			
	Message terminator	LF or EOM during reception, LF + EOM during transmission.			
LAN	Device class	Complies with the USBTMC-USB488 device class specifications.			
	Hardware	IEEE 802.3 100Base-TX/10Base-T Ethernet. Auto-MDIX compliant.IPv4, RJ-45 connector.			
	Compliant standards	LXI 1.4 Core Specification 2011			
Communication protocol	VXI-11, HiSLIP, SCPI-RAW, SCPI-Telnet				
	Message terminator	VXI-11, HiSLIP: LF or END during reception, LF + END during transmission. SCPI-RAW: LF during reception, LF during transmission.			
Display	7-inch LCD				

■ Other Functions (Common)

Item	TOS9300	TOS9301	TOS9302	TOS9303	TOS9303LC
Auto test	Auto execution by combining ACW, DCW, IR, and EC. For LC, a combination is possible only using TC, PCC, and Patient.				
Test condition memory	Setup memory	Up to 50 test conditions (ACW, DCW, IR, EC, LC) can be saved.			
	Program memory	Up to 125 program (ACW, DCW, IR, EC) combinations, each containing 100 steps, can be saved.			
	Program memory (LC)	Up to 125 program (TC, PCC, Patient) combinations, each containing 100 steps, can be saved.			
Test result memory	Records up to 1000 latest test result of independent tests and auto tests. These are cleared when the power is turned off. Test results can be saved in CSV format to a USB memory device.				
System clock	For recording the calibration time and test times				
Recordable time	Up to year 2038				
	Calibration period setting	Displays a warning at power-on when the specified period passes. Select whether to activate a protection function or only display a warning in the display area when a warning occurs.			
Measurement display	Maximum and minimum measurements can be displayed.				
Normal	Displays measurements during a test. Maximum and minimum values are not held.				
	Maximum and minimum value display	Displays the maximum current measurement for withstanding voltage (ACW/DCW) tests, the minimum resistance measurement for insulation resistance (IR) tests, the resistance measurement or voltage measurement for earth continuity (EC) tests.			
Test start method	Double Action	When you press STOP, "READY" is shown for 0.5 seconds. A test starts only when you press START within this period.			
	Momentary	Tests are only executed while the START switch is held down.			
	Start Long	A test starts only when the START switch is held down for at least 1 second.			
PASS judgment display time (Pass Hold)	Set the time to hold the pass judgment result display (0.05 s to 10.00 s) or hold it until STOP is pressed (Infinity).				
STOP signal disable (Fail Mode)	It is possible to set the instrument so that fail judgment results and PROTECTION mode cannot be released from a device connected to the SIGNAL I/O connector or REMOTE connector.				
Key lock	Lock the operation of the keys to prevent changing the settings or overwriting memory or programs by mistake.				

Other Functions (Common)

Item	TOS9300	TOS9301	TOS9302	TOS9303	TOS9303LC
Protection functions	If a protection function is activated during a test, the output is shut off and the test is stopped immediately. In an LC test, the power supply to the EUT is stopped, and the A and B terminals are opened. Conditions that cause a protection function to be activated are as follows.				
Interlock	Interlock is activated.				
Power Supply	There is an error in the power supply section.				
Output Error	An output voltage outside of the following range is detected. ACW, DCW, IR test: $\pm(10\% \text{ of setting} + 50 \text{ V})$ EC test: $\pm(10\% \text{ of setting} + 2 \text{ A})$				
Over Load	An output power outside of the following range is detected. ACW: 550 VA, DCW: 110 W, EC: 240 VA, LC: AC LINE OUT current exceeded approx. 15.75 A or the power exceeded 1600 VA.				
Over Heat	The internal temperature of the product is abnormally high.				
Over Rating	During a withstanding voltage test, an output current is generated for a length of time that exceeds the output time limit				
Cal	The preset calibration period is exceeded.				
Remote	The REMOTE connector is connected or disconnected.				
Signal I/O	There is a change in the SIGNAL I/O connector's ENABLE signal.				
Communication	An internal communication error is occurring.				
Over Range	A value exceeding the maximum value of the measurement range is detected.				
Measure	An error is detected in the LC test measurement check.				
Short	A relay operation error is detected in an LC test.				
Earth Fault	When the grounding mode (GND) is set to Guard, abnormal current flows from the high voltage output of this product to ground.				
Scan I/F	While scanning, the interface cable is disconnected. Or, the channel-assigned scanner is not detected.				

General Specifications (Common)

Item	TOS9300	TOS9301	TOS9302	TOS9303	TOS9303LC
Backup battery life	3 years (at 25 °C)				
Environment	Installation location		Indoors, 2000 m or less		
	Spec guaranteed range	Temperature	5 °C to 35 °C (41 °F to 95 °F)		
		Humidity	20 %rh to 80 %rh (no condensation)		
	Operating range	Temperature	0 °C to 40 °C (32 °F to 104 °F)		
		Humidity	20 %rh to 80 %rh (no condensation)		
	Storage range	Temperature	-20 °C to 70 °C (-4 °F to 158 °F)		
Humidity		90 %rh or less (no condensation)			
Power supply	Nominal voltage range (allowable voltage range)		100 Vac to 120 V, 200 V to 240 V (90 Vac to 132 V, 170 V to 250 V)		
	Power consumption	No load (READY state)	100 VA or less		
		Rated load	800 VA max.		
	Allowable frequency range		47 Hz to 63 Hz		
Insulation resistance (between AC LINE and chassis)		30 MΩ or more (500 Vdc)			
Withstanding voltage (between AC LINE and chassis)		1500 Vac, 1 minute, 20 mA or less			
Earth continuity		25 Aac, 0.1 Ω or less			
Weight	TOS9300: Approx. 17 kg (37.5 lb.), TOS9301: Approx. 18 kg (39.7 lb.), TOS9302: Approx. 20 kg (44.1 lb.), TOS9303: Approx. 21 kg (46.3 lb.), TOS9303LC: Approx. 22 kg (48.5 lb.)				
Accessories	Power cord (1 pc., *length: 2.5 m : The attached power cord varies depending on the shipment destination.) High-voltage test lead TL31-TOS (1 pair), SIGNAL I/O plug (1 set), High-voltage warning sticker (1 pc.), Setup Guide (1 copy), CD-ROM (1 disc), Safety Information (1 copy), Heavy object warning label (1 pc., *Not included with the TOS9300) Test leads for earth continuity test TL13-TOS (1 pair., *TOS9302, TOS9303, TOS9303LC only) [TOS9303LC only: Spare fuse (1 pc.), Test leads for leakage current test (2 red, 1 black), Flat probe (1 sheet)]				
Electromagnetic compatibility *1 *2	Complies with the requirements of the following directive and standards. EMC Directive 2014/30/EU EN 61326-1 (Class A *3), EN 55011 (Class A *3, Group 1 *4), EN 61000-3-2, EN 61000-3-3 Applicable under the following conditions The maximum length of all cabling and wiring connected to the product must be less than 2.5 m. Shielded cables are being used when using the SIGNAL I/O. The high-voltage test lead TL31-TOS is in use. Electrical discharges are applied only to the EUT.				
Safety *1	Complies with the requirements of the following directive and standards. Low Voltage Directive 2014/35/EU *2, EN 61010-1 (Class I *5, Pollution Degree 2 *6)				

*1 Does not apply to specially ordered or modified products.

*2 Limited to products that have a CE mark.

*3 This is a Class A instrument. This product is intended for use in an industrial environment. This product may cause interference if used in residential areas. Such use must be avoided unless the user takes special measures to reduce electromagnetic emissions to prevent interference to the reception of radio and television broadcasts.

*4 This is a Group 1 instrument. This product does not generate and/or use intentionally radio-frequency energy, in the form of electromagnetic radiation, inductive and/or capacitive coupling, for the treatment of material or inspection/analysis purpose.

*5 This is a Class I instrument. Be sure to ground this product's protective conductor terminal. The safety of this product is guaranteed only when the product is properly grounded.

*6 Pollution is addition of foreign matter (solid, liquid or gaseous) that may produce a reduction of dielectric strength or surface resistivity. Pollution Degree 2 assumes that only non-conductive pollution will occur except for an occasional temporary conductivity caused by condensation.

Specifications

■ High Voltage Scanner

[Basic specifications]

Item		TOS9320
Maximum operating voltage	AC	5 kV
	DC	7.2 kV
Number of channels	4 (Each channel can be set to high, low, or open.)	
Maximum connections	4 units Channel numbers are assigned according to the order in which connections are made to the TOS9300 series tester. 1st scanner: CH1 to CH4, 2nd scanner: CH5 to CH8, 3rd scanner: CH9 to CH12, 4th scanner: CH13 to CH16	
Contact check function	Available	
Indicators	DANGER	Lights in sync with the TOS9300 series tester
	CHANNEL	Indicates the setting of each channel with color. Red: High, Green: Low, Orange: Contact being checked, Off: Open
	EXTERNAL	Lights when external control is on
	POWER	Lights when the power is on

[Interface and other functions]

Item		TOS9320	
Control switch	EXTERNAL I/O switch for switching the following controls. ON: External control through the CONTROLLER INTERFACE OFF: Control from the TOS9300 series tester		
CONTROLLER INTERFACE (external control)	D-sub 25-pin connector.		
Function	Sets each channel to high or low or all channels to open. Outputs the setting of each channel.		
	Input	The input signals are all low-active control. The input terminal is pulled up to +12 V by a resistor. Leaving the input terminal open is equivalent to applying a high level signal.	
		High-level input voltage	11 V to 15 V
		Low-level input voltage	0 V to 4 V
		Low-level input current	-5 mA max.
	Input time width	5 ms min.	
	Output	Output method	Open collector output (4.5 Vdc to 30 Vdc)
		Output withstanding voltage	30 Vdc
		Output saturation voltage	Approx. 1.1 V (25°C, 77°F)
		Maximum output current	400 mA (TOTAL)
TOS9300 series tester interface	MINI DIN 8-pin connector. Accuracy guaranteed up to 4 units (16 channels)		

[General specifications]

Item		TOS9320	
Environment	Installation location	Indoors, 2000 m or less	
	Spec guaranteed range	Temperature	5°C to 35°C (41°F to 95°F)
		Humidity	20%rh to 70%rh (no condensation)
	Operating range	Temperature	0°C to 40°C (32°F to 104°F)
		Humidity	20%rh to 80%rh (no condensation)
	Storage range	Temperature	-20°C to 70°C (-4°F to 158°F)
Humidity		90%rh or less (no condensation)	
Power supply	Nominal voltage range (allowable voltage range)	100 Vac to 240 Vac (90 Vac to 250 Vac)	
	Power consumption	50 VA max.	
	Allowable frequency range	47 Hz to 63 Hz	
Insulation resistance (between AC LINE and chassis)		30 MΩ or more (500 Vdc)	
Withstanding voltage (between AC LINE and chassis)		1500 Vac for 1 minute, 20 mA or less	
Earth continuity		25 Aac/0.1 Ω or less	
Weight		Approx. 8 kg (17.6 lb)	
Accessories	Power cord (1 pc., length: 2.5 m: The attached power cord varies depending on the shipment destination.) High-voltage test lead [TL31-TOS] (8 red), Lead for high voltage parallelconnection TL33-TOS (1 pair), Interface cable (1 pc.), CONTROLLER INTERFACE plug (1 set), High-voltage warning sticker (2 pc.), Channel labels (For the panel (1 sheet), For the test leads (1 sheet)), User's manual (1 copy), Safety Information (1 copy)		
Electromagnetic compatibility *1 *2	Complies with the requirements of the following directive and standards. EMC Directive 2014/30/EU, EN 61326-1 (Class A *3), EN 55011 (Class A *3, Group 1 *4), EN 61000-3-2, EN 61000-3-3 Applicable under the following conditions The maximum length of all cabling and wiring connected to this product is less than 2.5 m. A shielded cable is used for the connection to the CONTROLLER INTERFACE. The high-voltage test lead TL31-TOS is in use. Electrical discharges are applied only to the EUT.		
Safety *1	Complies with the requirements of the following directive and standards. Low Voltage Directive 2014/35/EU *2, EN 61010-1 (Class I *5, Pollution Degree 2 *6)		

*1 Does not apply to specially ordered or modified products.

*2 Limited to products that have a CE mark.

*3 This is a Class A instrument. This product is intended for use in an industrial environment. This product may cause interference if used in residential areas. Such use must be avoided unless the user takes special measures to reduce electromagnetic emissions to prevent interference to the reception of radio and television broadcasts.

*4 This is a Group 1 instrument. This product does not generate and/or use intentionally radio-frequency energy, in the form of electromagnetic radiation, inductive and/or capacitive coupling, for the treatment of material or inspection/analysis purpose.

*5 This is a Class I instrument. Be sure to ground this product's protective conductor terminal. The safety of this product is guaranteed only when the product is properly grounded.

*6 Pollution is addition of foreign matter (solid, liquid or gaseous) that may produce a reduction of dielectric strength or surface resistivity. Pollution Degree 2 assumes that only non-conductive pollution will occur except for an occasional temporary conductivity caused by condensation.

External Dimensions (Unit:mm(inches))

TOS9300 **TOS9301**

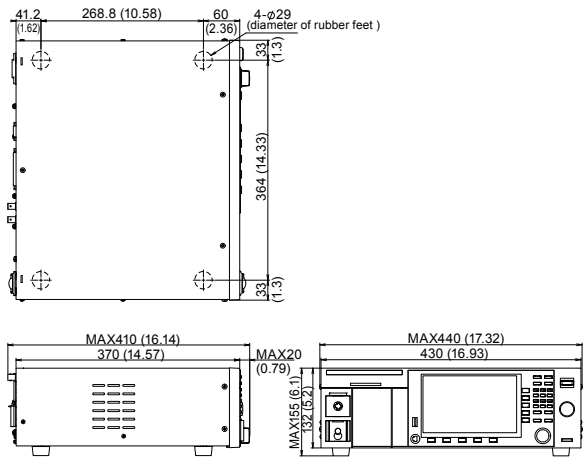

TOS9320

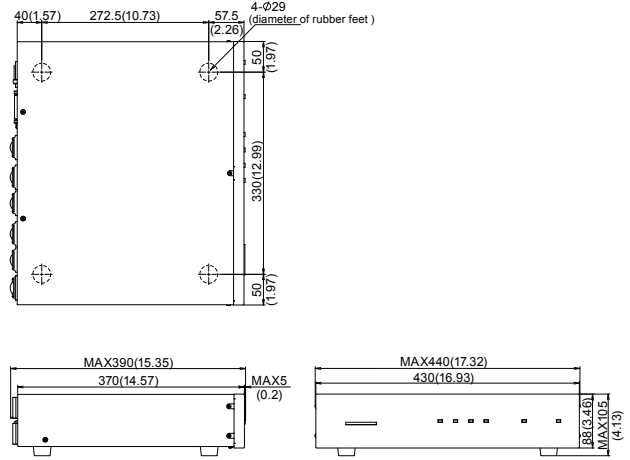

TOS9302 **TOS9303**

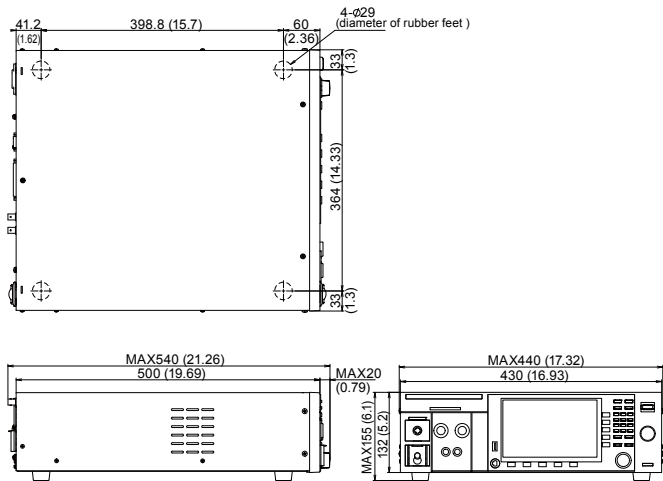

TOS9303LC

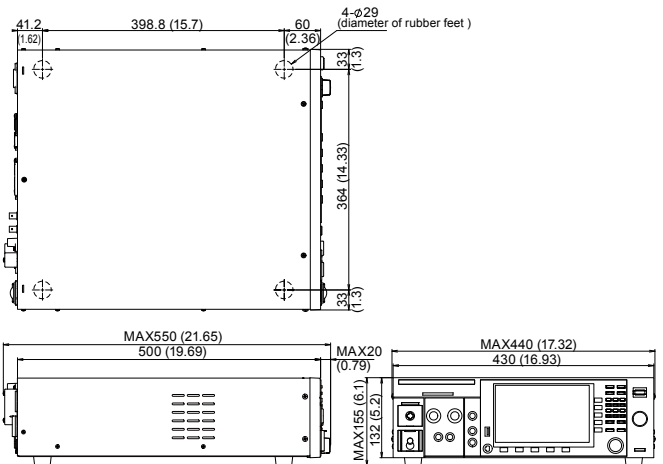

Option

High-Voltage Scanner

■ TOS9320



Dimensions(Maximum) / Weight

430(16.93")(440(17.32"))W×88(3.46")(105(4.13"))H×
370(14.57")(390(15.35"))Dmm/ 8 kg(17.6 lbs)

High Voltage Scanner for TOS9300 Series for Multi-Channel Testing Systems

The high voltage scanner TOS9320 is a specialized option for the TOS9300 series, capable of rapidly distributing test voltage from the main unit to multiple testing points for withstanding voltage and insulation resistance testing. Channels can be controlled with an external device through the back panel CONTROLLER INTERFACE connector. Remote control is not limited to the TOS9300 series but is also compatible with previous models such as the TOS5300 series hipot/insulation resistance tester. The TOS9320 high-voltage scanner is an essential tool for the automation of highly reliable testing of electronic devices among multiple channels.

Features

- Output can be expanded to four channels with one high-voltage scanner. The electric potential of each channel can be arbitrarily set to high, low, or open, and can be tested at any of these four points.
- Up to four high voltage scanners (total 16 channels) can be connected to each unit.
- Output of each channel and contact with testing points can be easily monitored.

Remote Control Box

The remote control box can be used to start and stop withstanding voltage and insulation resistance tests. One model is for use with one hand, and the other model is for use with two hands.

■ RC01-TOS (One-hand operation/1.5 m)



*DD-5P/9P DIN conversion cable required for connection with TOS9300 series.

■ RC02-TOS (Two-hand operation/1.5 m)



*DD-5P/9P DIN conversion cable required for connection with TOS9300 series.

DIN Conversion Cable

The DIN (5 pin → 9 pin) conversion cable is used for connection with the following optional products and the TOS9300 series.

- Remote control box(RC01-TOS/RC02-TOS)
- High voltage test probe(HP01A-TOS/HP02A-TOS)

■ DD-5P/9P Adaptor/DIN to Mini DIN



Warning Light Unit

The warning light unit indicates when the TOS9300 is performing a test, making clear that a test is in progress from a distance.

■ PL02-TOS (for AC/DC24 V)



Multi Outlet

The multi outlet OT01-TOS can be used to connect to main plugs throughout the world by connecting to the AC LINE OUT terminal block of the EUT power supply

■ OT01-TOS
for TOS9303LC



High Voltage Test Probe

This probe is used for generating test voltage. This probe has been designed to only generate test voltage when the user operates the probe with both hands in order to prevent accidental test voltage generation.

- HP01A-TOS (Max.AC4 kV • DC5 kV/1.8 m)
- HP02A-TOS (Max.AC4 kV • DC5 kV/3.5 m)



*DD-5P/9P DIN conversion cable required for connection with TOS9300 series.

Rack Mount Bracket

Complied Model	JIS Standard	EIA Standard
	Bracket Model Name	Bracket Model Name
TOS9300 TOS9301 TOS9301PD TOS9302 TOS9303 TOS9303LC	KRB150-TOS 	KRB3-TOS
	KRB100-TOS 	KRB2-TOS
TOS9320		

Others

High-Voltage Digital Voltmeter

- Measurement of high voltages (AC/DC) of up to 10 kV maximum
- Large 4 1/2 digit LED display
- High measuring accuracy and input resistance
- Light weight of only 3 kg
- Compact design
- Excellent ease of maintenance

■ 149-10A



Specification	
Type	Double integration type. (sampling cycle: 3 times/sec)
DC Voltage	Measuring range: 0.500 kV to 10,000 kV Accuracy: $\pm(0.5\% \text{ of reading} + 0.03\% \text{ of range})$ Input resistance: 1000 M Ω $\pm 2\%$
AC Voltage	Measuring range: 0.500 kV to 10,000 kV Accuracy: $\pm(1\% \text{ of reading} + 0.05\% \text{ of range})$ Frequency characteristics: 50/60 Hz (sine wave rms value display of mean value response) Input resistance: 1000 M Ω $\pm 2\%$
Power	100 V $\pm 10\%$, Approx. 10 VA
Dimensions (MAX)	134[5.27 inch]W \times 164[6.46 inch]H \times 270[10.63 inch]D mm (140[5.51 inch]W \times 189[7.44 inch]H \times 350[13.78 inch]D mm)
Weight	Approx. 3 kg (6.6 lbs)
Accessories	TL05-TOS High voltage test leads: 1 HTL2.5DH High voltage test lead: 1

Calibration Resistor for Insulation Resistance Tester

The 929 Series Standard Resistors are for calibration of Insulation Testers.

- 929-1M (1 M Ω)
- 929-10M (10 M Ω)
- 929-100M (100 M Ω)



Specification	
Nominal Resistance	1 M Ω (929-1M)/ 10 M Ω (929-10M) 100 M Ω (929-100M)
Accuracy of Resistance	1 % at 25 °C ± 10 °C
Temperature Coefficient	100 ppm/°C or better
Voltage Coefficient	1 ppm/V or better
Working voltage rating	1.2 kV
Dimensions (MAX)	64[2.52 inch]W \times 24[0.94 inch]H \times 30[1.18 inch]D mm

*The 929 series standard resistors can not be installed directly to the TOS series. Please use the test lead for connection.

Hipot Tester Current Calibrator

- Calibration of Leakage Current Detection Sensitivity
- Direct Reading of Error from Error Display Scale
- Ammeter Ranges
- Eliminates Need for Power Supply
- AC/DC Selection Switch

■ TOS1200



Specification			
Measuring Function	Measurement of current values and error(%) for AC (50/60 Hz) and DC at a test voltage of 1000 V		
Measuring Ranges	8 ranges consisting of 0.5/1/2/5/10/20/50/100 mA along with values equal to 0.8 times the values of those ranges (for 1, 2, 4 and 8 steps)		
Ammeter Scale	Main scale: Direct-reading error display scale over a range of $\pm 10\%$ of the above full scale values Auxiliary scale: Ratio scale of 0 to 1.1 times the above full scale values (equivalent to 0% display of main scale when the ratio is equal to 1)		
Ammeter Accuracy	Main scale: $\pm 1\%$ of reading Auxiliary scale: $\pm 3\%$ of full scale value		
Ammeter Indication	DC/AC (sine wave rms value calibration of mean value response)		
Load Resistance			
Range[mA]	Resistance[k Ω]	Range[mA]	Resistance[k Ω]
0.5	2000	10	100
1	1000	20	50
2	500	50	20
5	200	100	10

Allowed Input Time 0.5/1/2/5 mA ranges: Continuous
10/20/50/100 mA ranges: 60 sec.
Max. 1/3 of duty cycle

Dimensions (MAX) 134[5.28 inch]W \times 164[6.46 inch]H \times 270[10.63 inch]D mm
(140[5.51 inch]W \times 190[7.48 inch]H \times 310[12.20 inch]D mm)

Weight Approx. 3.5 kg (7.72 lbs)

Accessories TL04-TOS High-voltage test lead: 1

UL Resistance Load

This device is described in section 125, paragraph 2-1B1 of UL1492. The RL01-TOS is a variable load resistor for checking the output voltage of hipot testers used in dielectric strength testing on production lines. (Complies with UL regulations including UL1270, UL1409 and UL1410.)







■ RL01-TOS



Specification	
Resistors	120 k Ω / 159 k Ω / 210 k Ω / 279 k Ω / 369 k Ω / 489 k Ω / 648 k Ω / 858 k Ω / 1,137 k Ω / 1,500 k Ω / 1,989 k Ω / 2,148 k Ω
Resistance Accuracy	+1 %, -0 % of nominal value when set to 120 k Ω , $\pm 1\%$ of nominal value when set to other values
Maximum Operating Voltage	1300 V (continuous rating)
Maximum Overload Voltage	1400 V for 5 seconds (application may not be repeated within 1 minute)
Dimensions (MAX)	200[7.87 inch]W \times 100[3.94 inch]H \times 260[10.24 inch]D mm (210[8.27 inch]W \times 120[4.72 inch]H \times 295[11.61 inch]D mm)
Weight	Approx. 2.6 kg (5.73 lbs)
Accessories	TL04-TOS High-voltage test lead: 2 TL05-TOS High-voltage test lead: 1

Lineup Overview

●Electrical Safety Multi-analyzer

Model	Test items					
	 AC Withstanding Voltage (AC Hipot)	 DC Withstanding Voltage (DC Hipot)	 Insulation Resistance	 Earth Continuity (Ground Bond)	 Leakage Current	 Partial Discharge
TOS9300	●		●			
TOS9301	●	●	●			
TOS9301PD <small>Under development</small>	●	●	●			●
TOS9302	●			●		
TOS9303	●	●	●	●		
TOS9303LC	●	●	●	●	●	

●Option

Description	Model	Remark
High-voltage scanner	TOS9320	4 channel high voltage scanner with contact check function; can be used standalone
Remote control box	RC01-TOS	One-hand operation/1.5 m
	RC02-TOS	Both-hands operation/1.5 m
DIN conversion cable	DD-5P/9P	It is required when RC01-TOS/RC02-TOS, HP01A-TOS/HP02A-TOS and HP21-TOS is used
High voltage test probe	HP01A-TOS	Max.AC4 kV • DC5 kV/1.8 m
	HP02A-TOS	Max.AC4 kV • DC5 kV/3.5 m
Test probe for touch current test	HP21-TOS	Test probe for TOS9303LC. Max.250 V rms • 100 mA/ 1.8 m
Warning light unit	PL02-TOS	for AC/DC24 V
Multi outlet	OT01-TOS	for TOS9303LC
Rack mount bracket	KRB150-TOS	JIS standard (mm) for TOS9300/9301/9301PD/9302/9303/9303LC
	KRB3-TOS	EIA standard (inch) for TOS9300/9301/9301PD/9302/9303/9303LC
	KRB100-TOS	JIS standard (mm) for TOS9320
	KRB2-TOS	EIA standard (inch) for TOS9320



KIKUSUI ELECTRONICS CORPORATION

Southwood 4F,6-1 Chigasaki-chuo,Tsuzuki-ku,Yokohama,224-0032,Japan
Phone: (+81)45-482-6353,Facsimile: (+81)45-482-6261,www.kikusui.co.jp

KIKUSUI AMERICA, INC. 1-310-214-0000 www.kikusuiamerica.com



3625 Del Amo Blvd, Suite 160, Torrance, CA 90503
Phone : 310-214-0000 Facsimile : 310-214-0014

KIKUSUI TRADING (SHANGHAI) Co., Ltd. www.kikusui.cn



Room 305,Shenggao Building ,No.137,Xianxia Road, Shanghai City, China
Phone : 021-5887-9067 Facsimile : 021-5887-9069

For our local sales distributors and representatives, please refer to "sales network" of our website.

● Distributor/Representative

■ All products contained in this catalogue are equipment and devices that are premised on use under the supervision of qualified personnel, and are not designed or produced for home-use or use by general consumers. ■ Specifications, design and so forth are subject to change without prior notice to improve the quality. ■ Product names and prices are subject to change and production may be discontinued when necessary. ■ Product names, company names and brand names contained in this catalogue represent the respective registered trade name or trade mark. ■ Colors, textures and so forth of photographs shown in this catalogue may differ from actual products due to a limited fidelity in printing. ■ Although every effort has been made to provide the information as accurate as possible for this catalogue, certain details have unavoidably been omitted due to limitations in space. ■ If you find any misprints or errors in this catalogue, it would be appreciated if you would inform us. ■ Please contact our distributors to confirm specifications, price, accessories or anything that may be unclear when placing an order or concluding a purchasing agreement.